

Smart embedded Voltage Control Sensor for individual elements of a fuel cell stack

FC_tools 09 Trondheim

Alain GIRAUD
alain.giraud@cea.fr

Francis ROY
francis.roy1@mps.com

PSA PEUGEOT CITROËN

Direction de la Recherche et de l'Innovation Automobile

FiSYPAC is the first project which leads to the vehicle integration of GENEPAC fuel cell stacks.

GENEPAC technology :
high performances 1.5kW/L and 1kW/kg

Technical Achievements :
Speed:155 km/h H₂= 1,1kg/100km
Autonomy :500 km

FISYPAC
Life time improvement

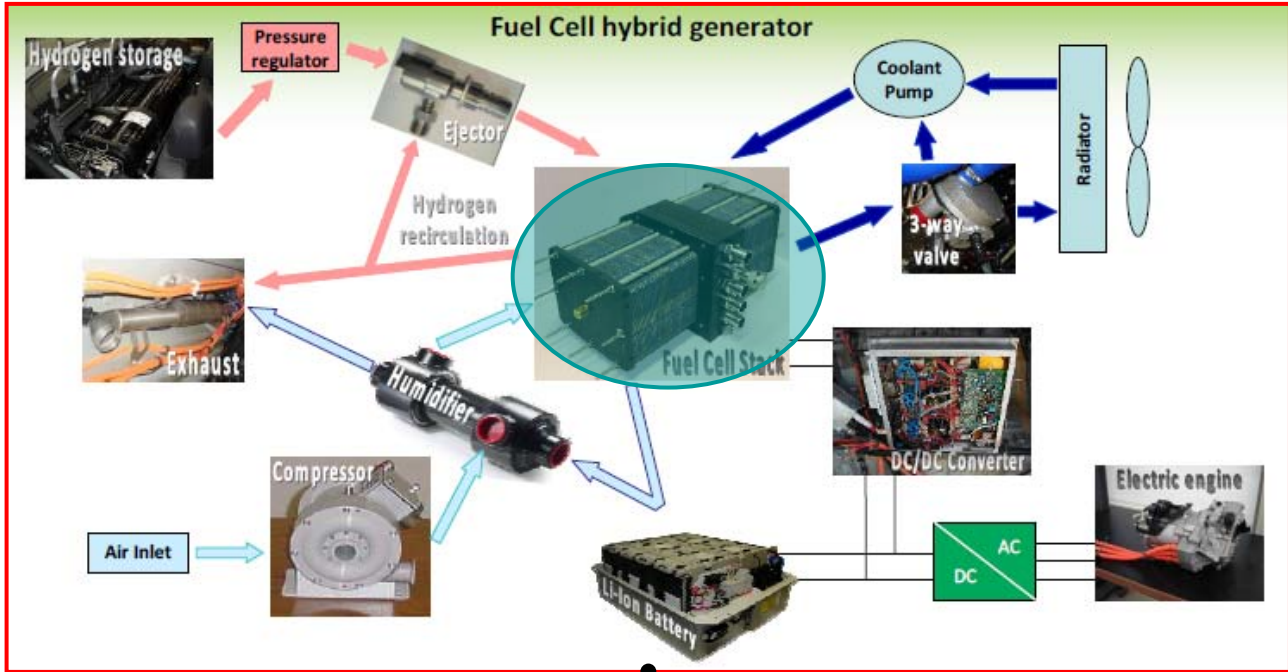

FISYPAC
Stationary performance

Vehicle architecture :
Electrical motor
Li-Ion battery (75-500kms)
Charged by recovering energy
High pressure storage tank 1.5kW/L
1kW/kg



FCS on-line features:
60°-85°C
20-140A
10-16 bars on H₂ entrance
50% of humidity

- Fisypac : the fuel cell control
- Specification of monitoring module
- Design of the module
- Test and validations
- New approach with sensors based on GMR
- Designs
- Tests and validations
- Conclusions

- Voltage control dispersion
 - 0,3V to 1,28V for an individual cell
 - 38,4V to 153,6V for the stack)
- Resolution
 - +/-1% from 60°C to 85°C (nominal temperature) => +/-10mV
 - +/-5% from -20°C to 60°C (intermediate)
- Alarm thresholds
 - 0,4V information / 0,3V emergency
- Control loop
 - 500ms
- Board mechanical constraints
 - Screwed on stack back-bone
 - No compatibility between electronic space common standards and Individual cell plug: minimum flat cable wiring
 - Arrangement to equilibrate flat cable wiring between cells and board
- Galvanic insulation
 - Simple opto electronic components assume 1500V galvanic insulation between stack (350V with large tolerance) and vehicle grounded units
- Board organization
 - Induced a splitting into three modules of the functions embedded on the board
- CAN networking
 - CAN 1 : for each fuel cell emergency frames with alarm and emergency bits positioned when thresholds are crossed
 - CAN 2 : for each fuel cell current voltage values

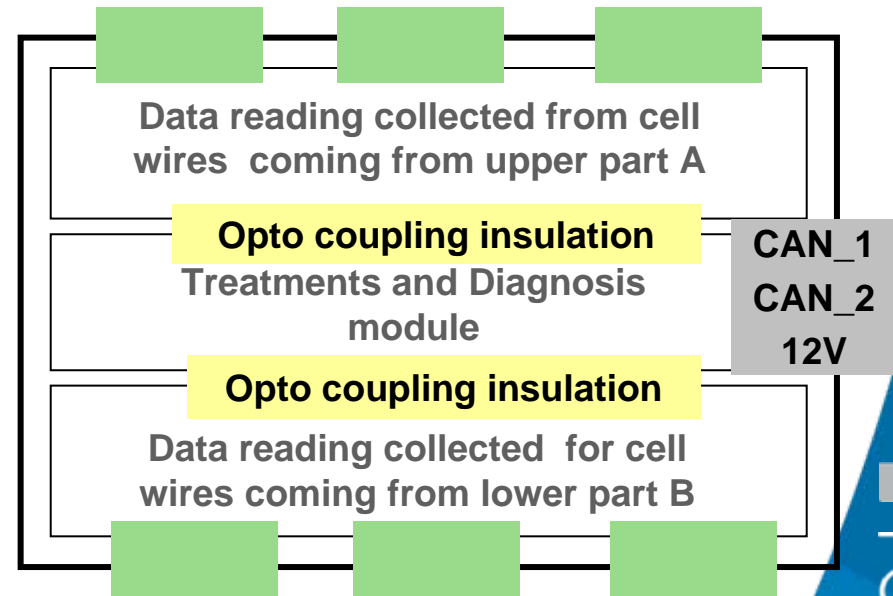
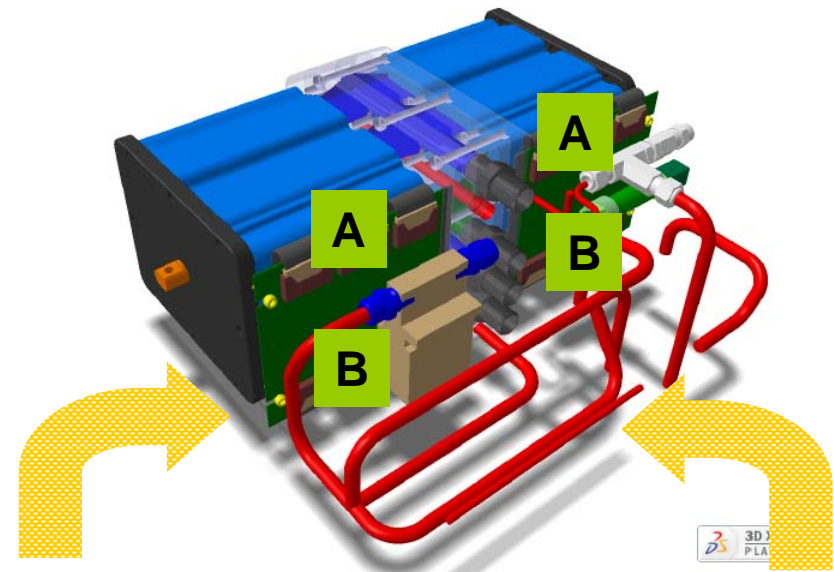

Reading and diagnosis system

Galvanic insulation fixed to 1500V between fuel cells and 12V battery

Opto-electronic barrel

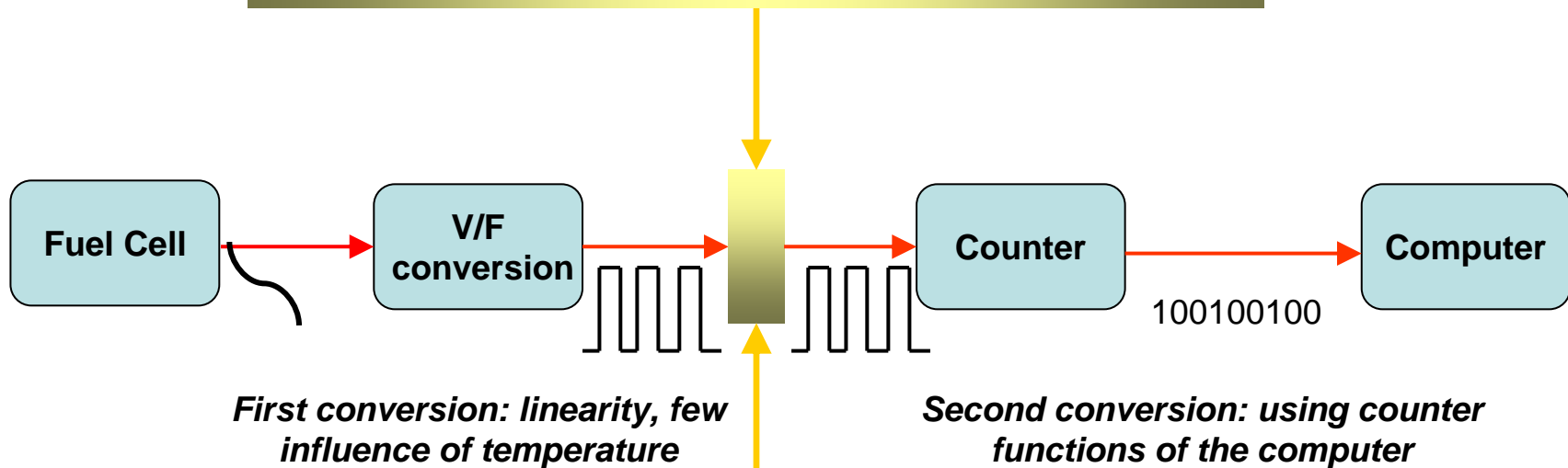

- *analog signals are affected by emissivity and photo current restitution in presence of temperature*
- *binary signals are less sensible to opto barrel*

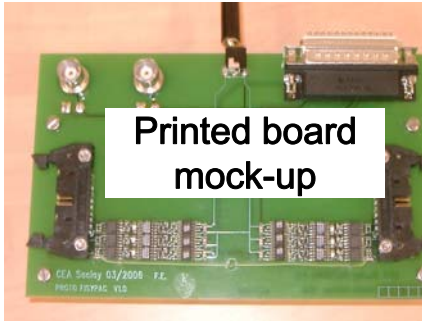

Printed board mock-up

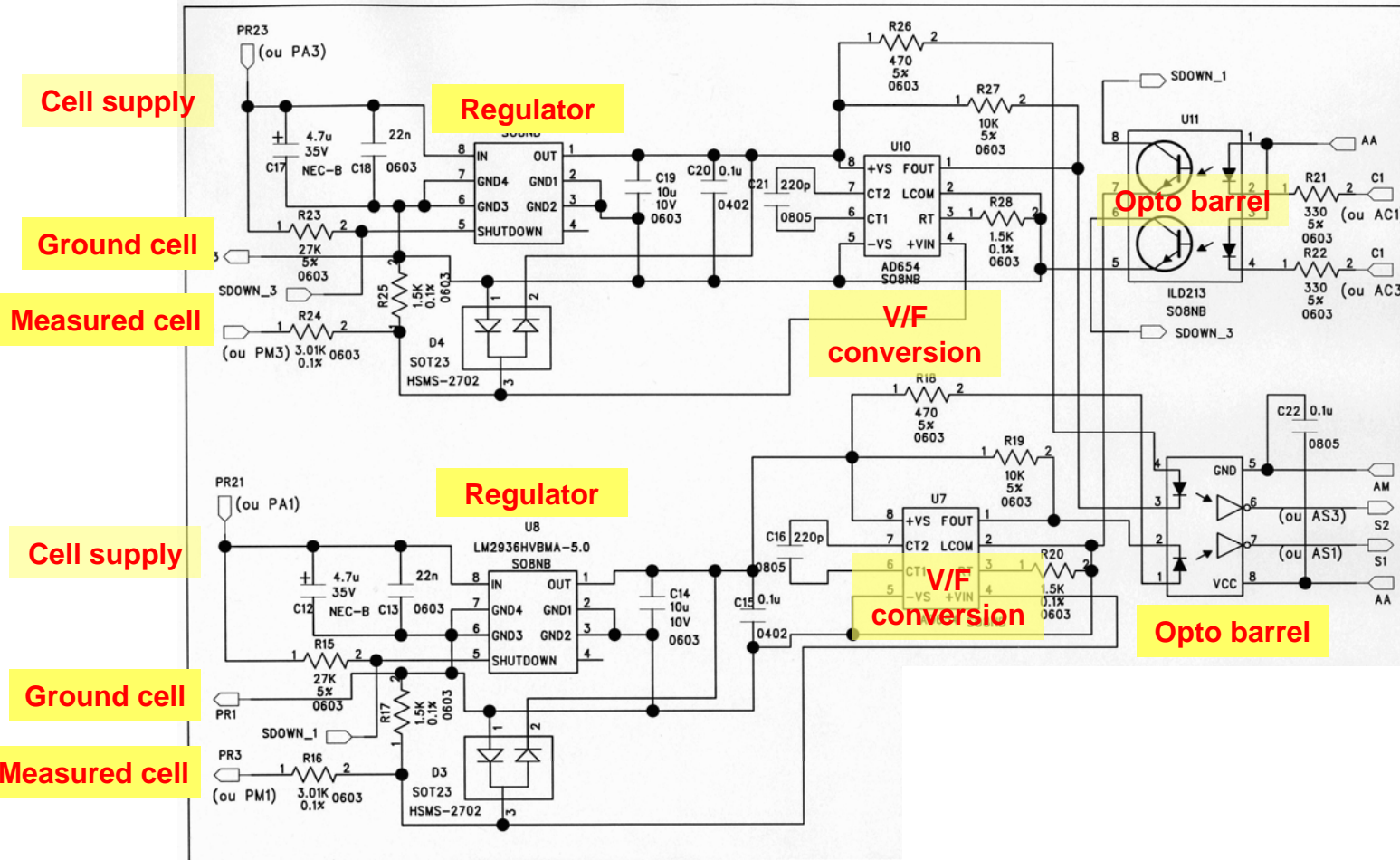
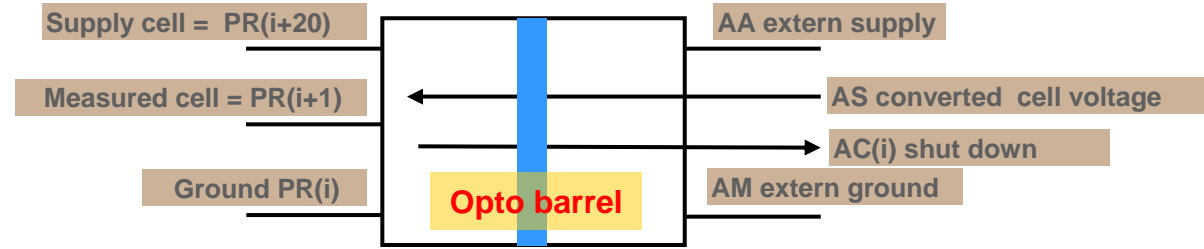

fisypac_proto_new_sch-2 - Tue Apr 25 12:20:33 2006

- Prototyping board (as near as possible final embedded board)
 - ARM MAC7111 (automotive guarantees)
 - I/O, timers
 - CAN
 - JTAG probe for downloading and debugging
 - Development PC with debuggind, downloading, compiler and CAN interface
- Binary to counted signals
 - Best choice for timer conversion functions
- Test bench
 - combining mock-up with 12 measurements cells, prototype board and sell simulation (supply)
 - Embedded software nearby FISYPAC application
- Results
 - For each measured cell, linearity of computed data versus analog supply simulating cell voltage
 - External supply to replace fuel cell
 - 10mV increments to verify accuracy and repeatability
 - Computation to determine coefficients of linear function which identify the transfer response of measurement cell
 - Control of emergency thresholds
 - CAN frames organization (automotive protocol)

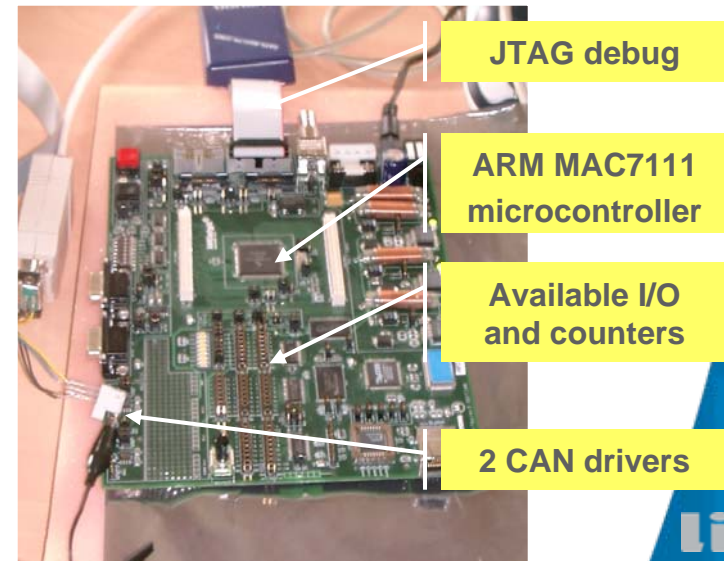

● Mock-up validation

- Precision < 10mV effective
- No significant variation due to temperature or batches dispersion
- Efficient calibration

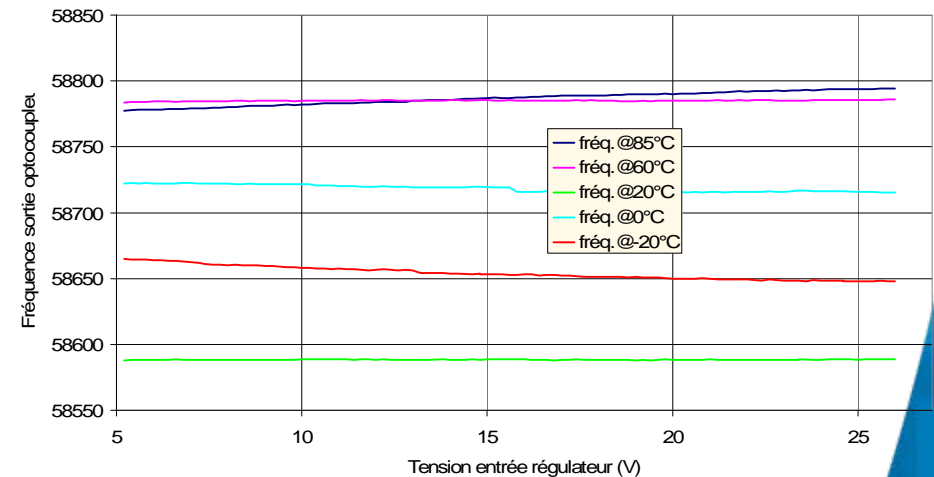
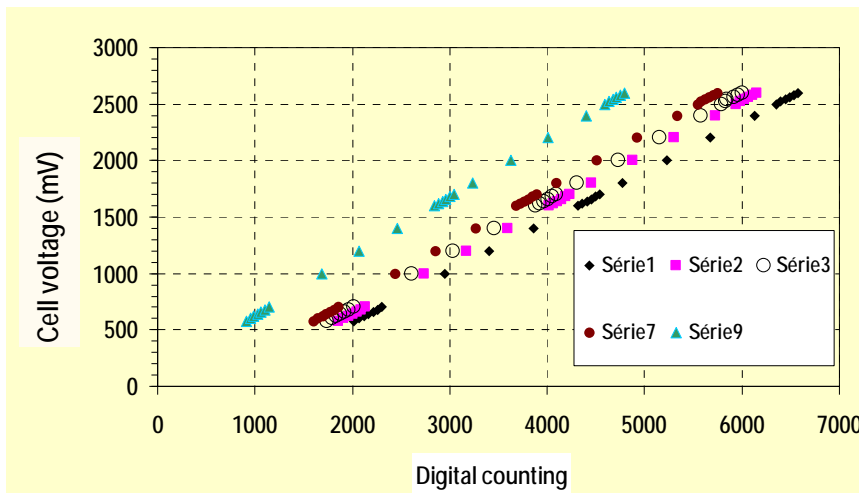

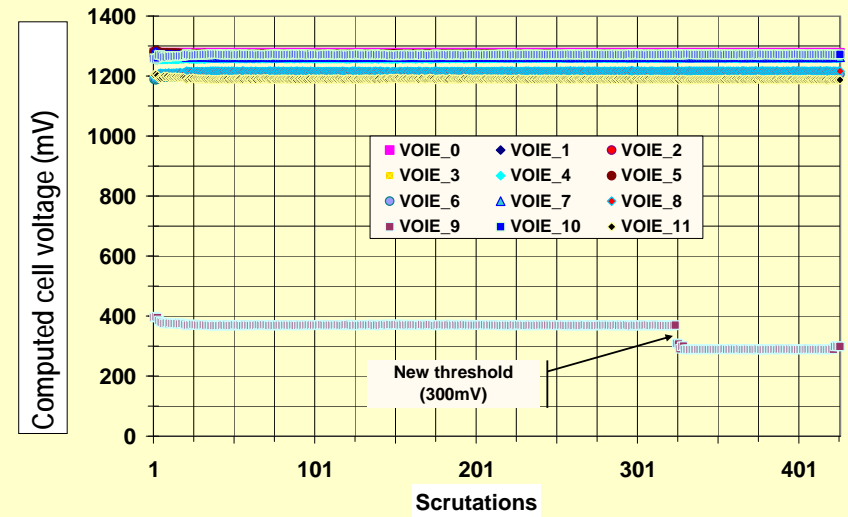
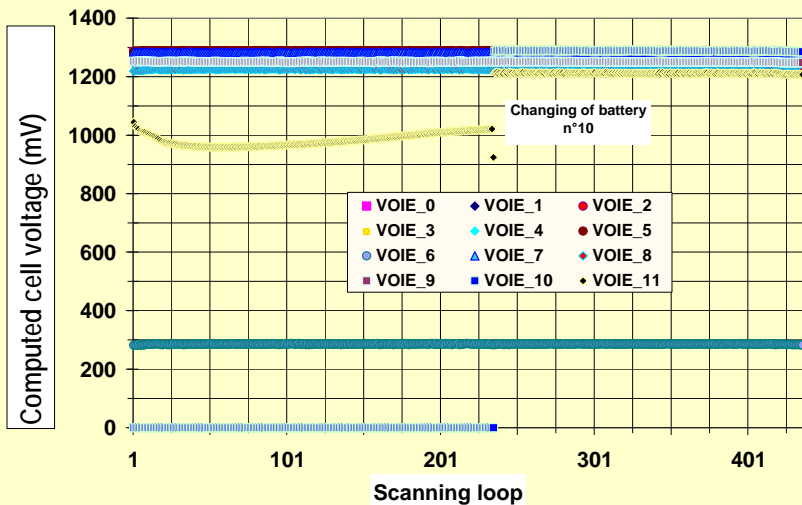

Computed voltage

- Computed voltage reconstitute correct cell voltage
- Occurrence of event (modification of threshold voltage, exchange of batteries)
- Without further temperature tests

● Prototype board

- Design based of 12 cells mock-ups
- Use of printed boards layers to equilibrate charge of the pile and access to the counters of treatment module
- calibration of all elements
- Final validation of embedded software (automotive protocol PSA)
- Test and validation at LITEN facility
- Test and validation in-situ in automotive conditions
 - In lab conditions
 - On-going on road conditions

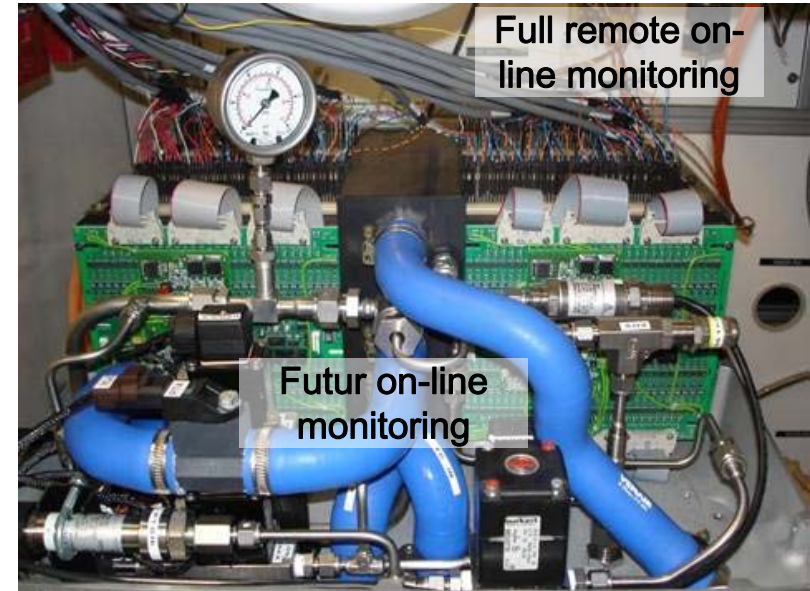
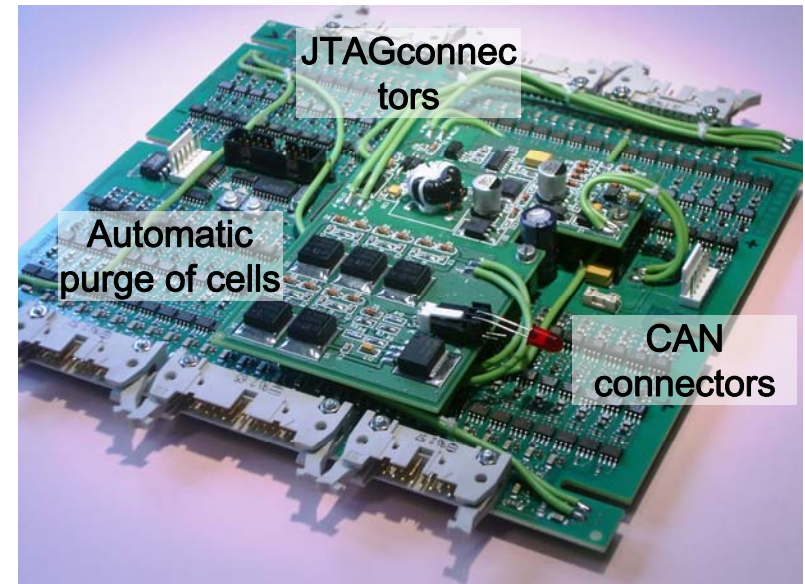

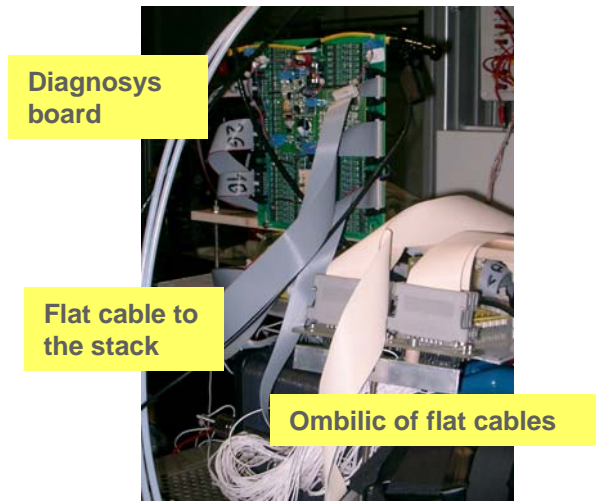
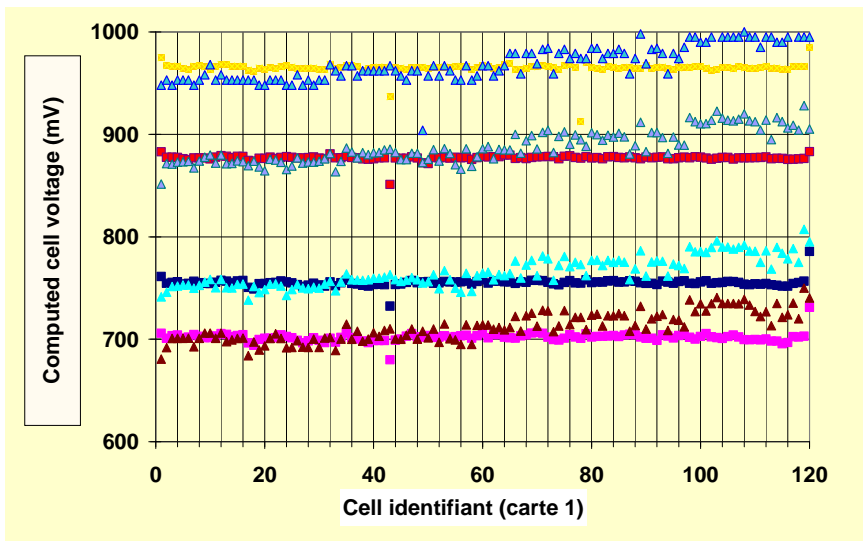
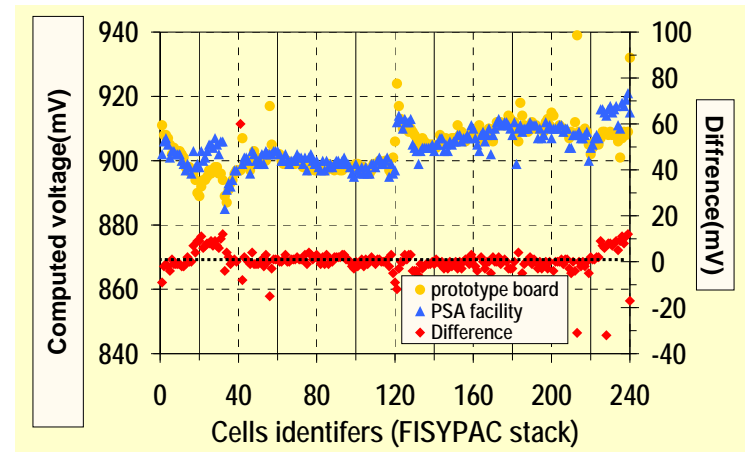
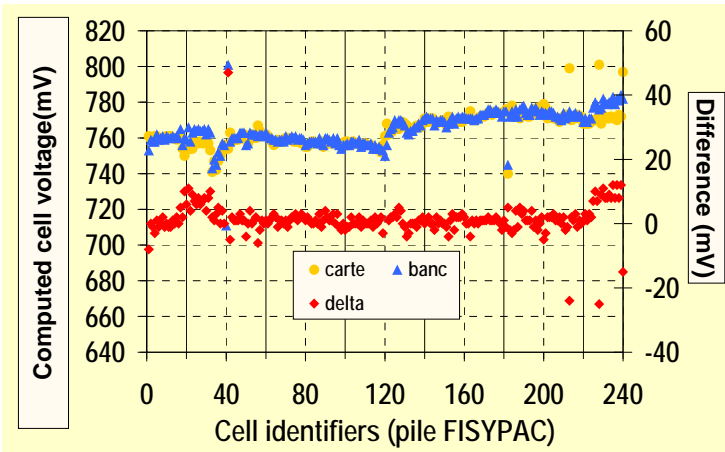

Tests on LITEN facility

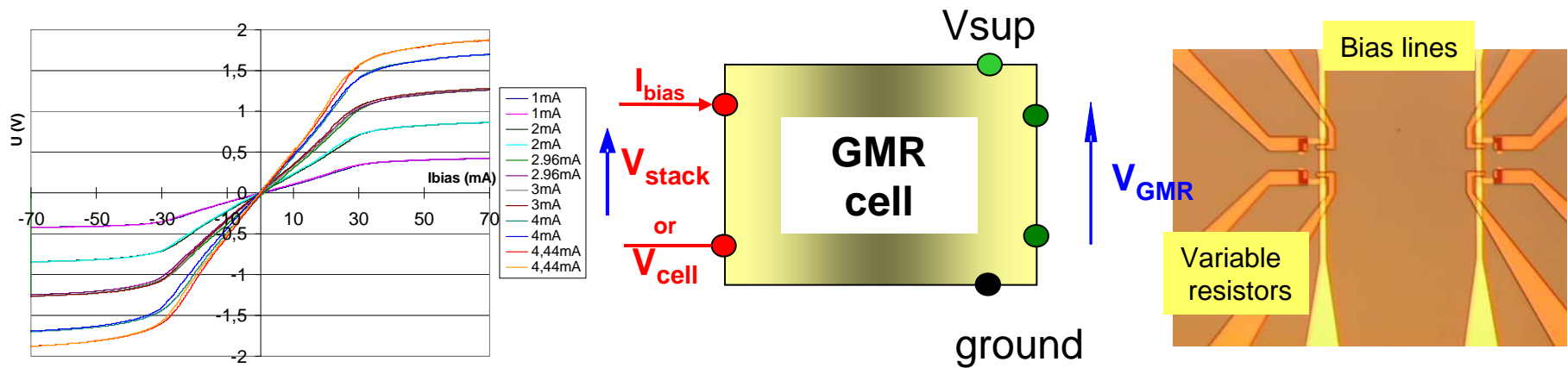

Features:

- a current circulating into bias lines induces a magnetic field detected by resistors whose value depends on the magnetic field encountered (named GMR).
- The magnetic field is not affected by the insulation layers between bias lines and GMR resistor, which allows an intrinsic galvanic insulation
- The linearity of the conversion is very efficient

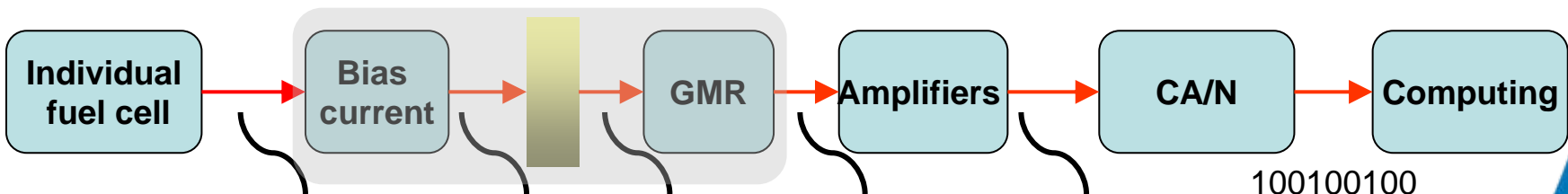

● Behavior of a single GMR

- Very linear comportment of cell voltage conversion
- Inherent low offset
- Sensitivity to temperature
 - Appears as homogeneous and linear
 - Computed correction (treatment module)
 - Compensation by technology
 - Not possibility to evaluate lot effect production
- Next step, design of a barrel

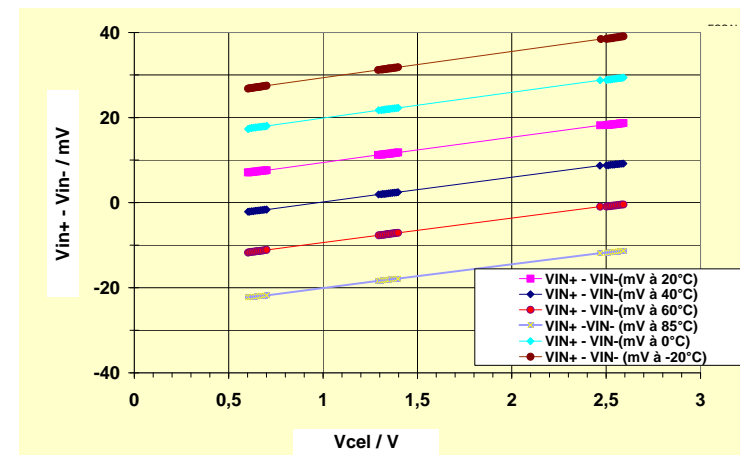
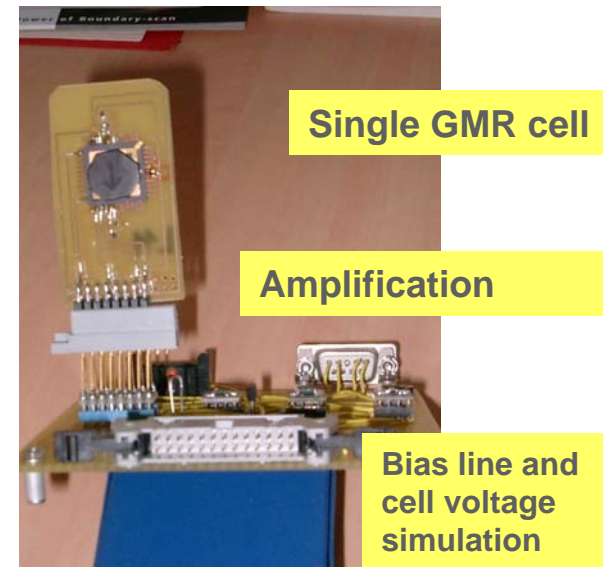

Barrel design

- Could be seen as nano and micro design and production with various processes
 - Low offset
 - Few drifts observed in temperature environments
 - Some drifts on bias resistors
- No dispersion on the barrel

Insulation difficulties

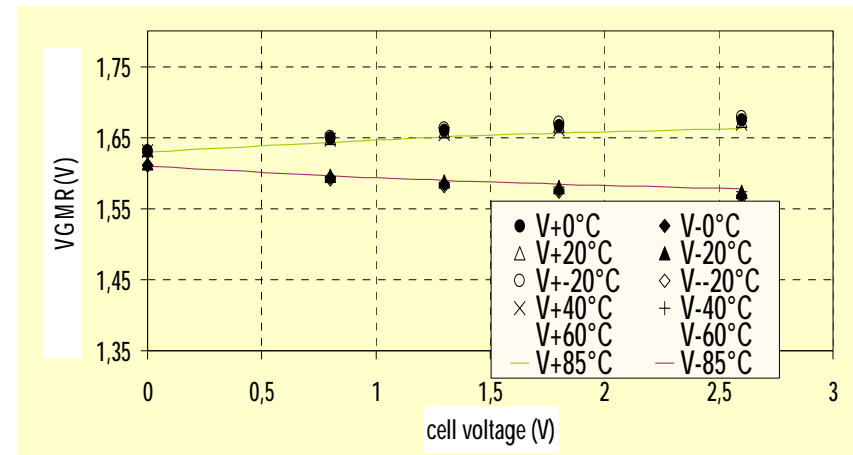
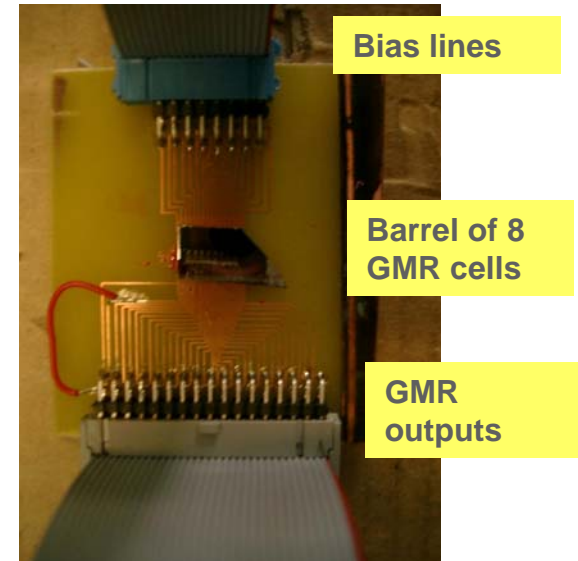

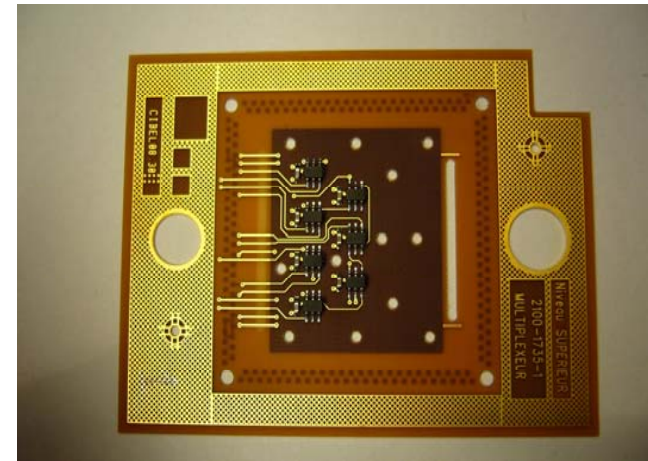
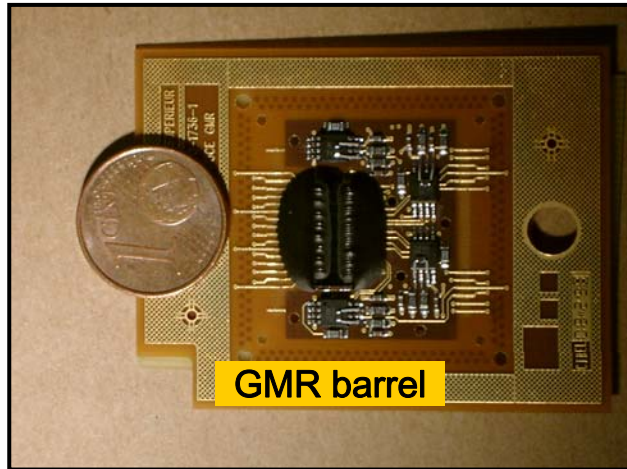

- Design of an hybrid model
 - GMR barrel
 - Discrete instrumentation stage
- Packaging
 - Multilayer
 - Interconnection
- Results
 - Linearity
 - Existing offset
 - Accuracy

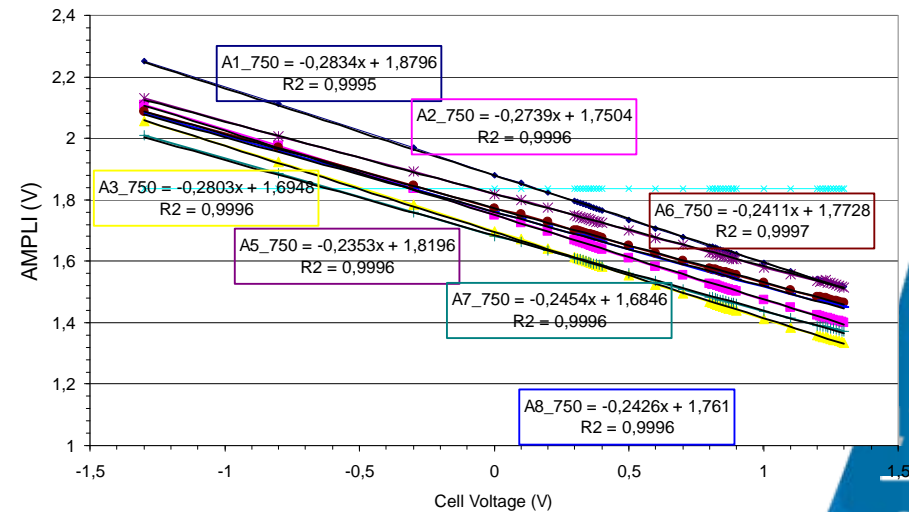

- Applications involving a large number of cells or stacks needs an efficient and faithful smart embedded control board to deal with emergency technics when single or multiple cells become degraded or failed
- Our on-line monitoring tools are involved in an automotive application? Validation for validation is on-going.
- Recent GMR technology offers an appreciable opening to modern nano or micro sensors for monitoring of cell or stack voltage (and probably other parameters not yet tracked). The prototype board will be soon produced and validate on 200-400 cells stacks.
- Nevertheless, as for electronic technologies, such an innovative approach will deal with industries interest only when technologies become stable with a significant life-time. This will be done for designers and founders when an identified volume market will be appreciate.

Thank you for your attention!!

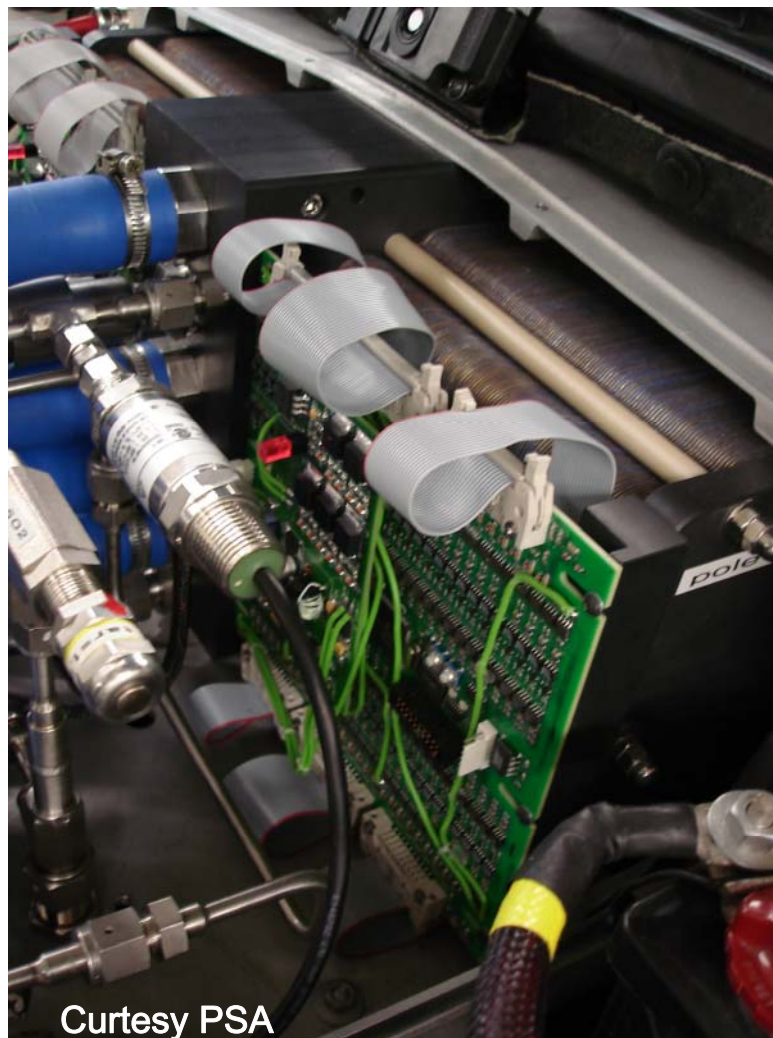

Courtesy PSA