FRAUNHOFER INSTITUTE FOR SOLAR ENERGY SYSTEMS ISE

Approaches and Methodology on Accelerated Stress Tests in Fuel Cells



Nada Zamel

Fraunhofer Institute for Solar Energy
Systems ISE

First International Workshop on Durability
and Degradation Issues in PEM Electrolysis
Cells and its Components

Freiburg, 12-13.03.2013

www.ise.fraunhofer.de

AGENDA

- Quick Introduction
- Membrane degradation
 - (1) Mechanisms (2) Characterization (3) General AST (4) DOE AST
- Electrode degradation
 - (1) Mechanisms (2) Characterization (3) General AST (4) DOE AST
- GDL degradation
 - (1) Mechanisms (2) General AST
- Bipolar Plates
 - (1) Mechanisms (2) General AST
- EU protocols
- Outlook

General Overview

- Performance of the cell/stack is discussed in terms of the following:
 - Reliability – ability of the cell/stack to perform the required function under specified conditions for a period of time
 - Durability – ability of the cell/stack to resist permanent change over time
 - Stability – ability of the cell/stack to recover power lost during continuous operation
- AST is used to test the above characteristics
 - Goal is to degrade each component separately

Construction of a PEM fuel cell

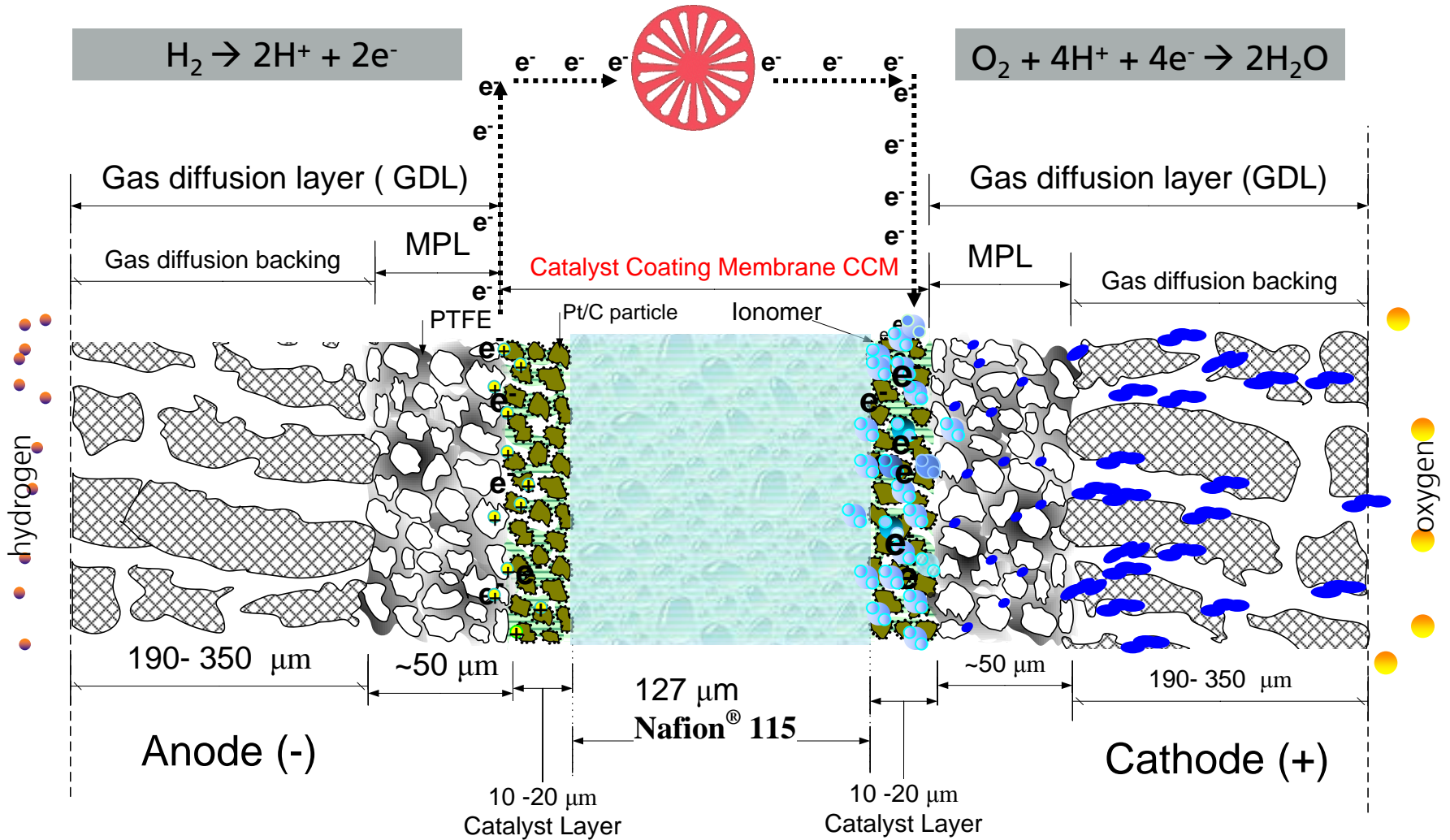

Steady-state versus Accelerated Stress Tests

- Steady-state degradation testing is expensive
- Accelerated stress tests are designed to mimic failure under real-life conditions

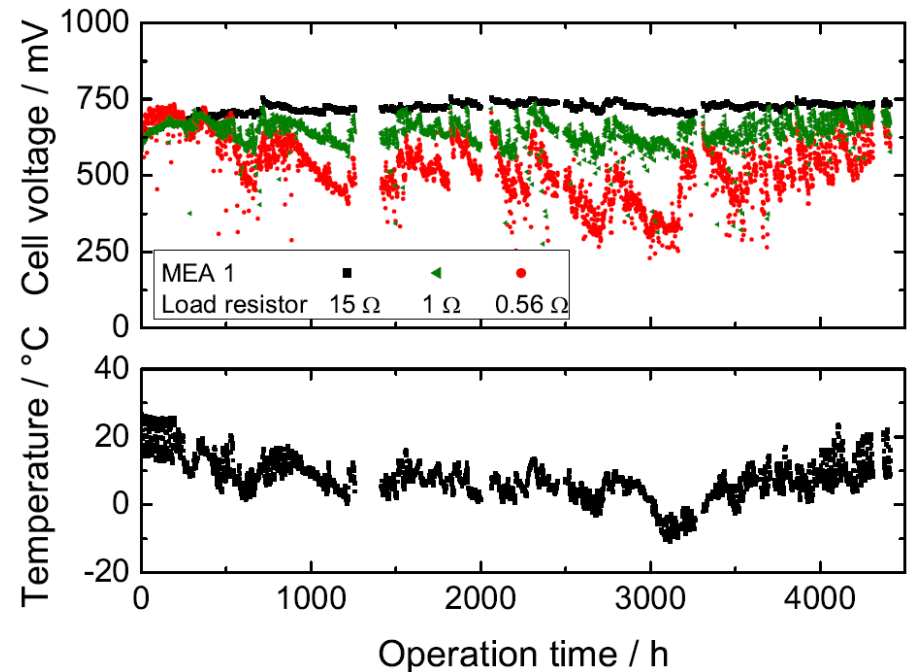

Biesdorf J., Binninger T., Zamel N., Kurz T. Submitted to Journal of Powers Sources.

AGENDA

- Quick introduction
- Membrane degradation
- Electrode degradation
- GDL degradation
- Bipolar plate degradation
- EU protocols
- Outlook



Mechanisms of membrane degradation

→ Chemical degradation

- Attack by radicals
 - hydroxyl (.OH) and peroxy (.OOH) radicals
- Contamination by ionic species
 - Sources → metal bipolar plates, tubing materials ...

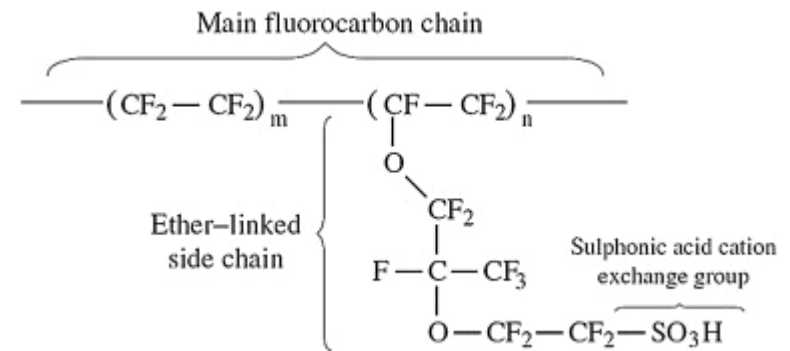

Mechanisms of membrane degradation

→ Mechanical failure and physical changes

- Mechanical failure is crucial for thin membranes (~25 μ m)
 - Pinholes and foreign materials initiate propagating cracks
 - Due to non-uniform contact pressure
- Change of Nafion morphology
 - Crystallinity changes during operation
 - A high crystallinity corresponds to open-ion channels
 - Dehydrated, collapsed channels correspond to a decrease in crystallinity

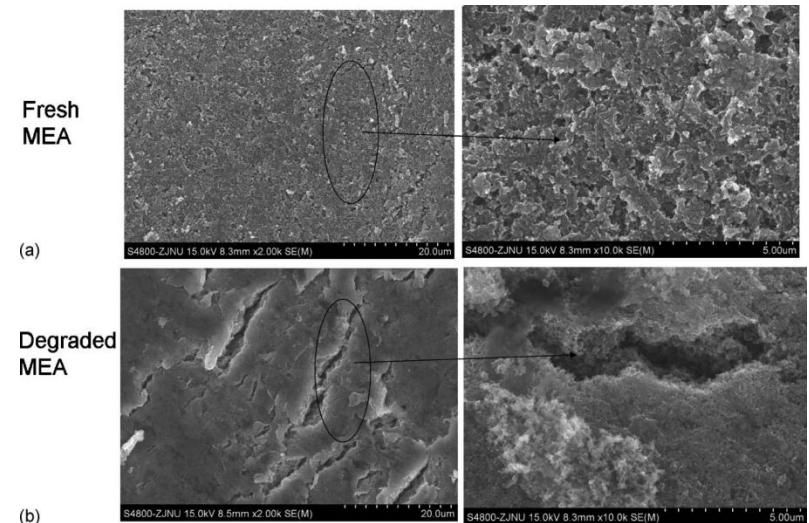

Lin et al., *Journal of The Electrochemical Society*, **158** 1 B11-B17 2011

Characterization of membrane degradation

- Fluoride release rates
 - Correlates the rate of release of fluoride ions to chemical degradation
- Hydrogen crossover rates
 - Relies on the current due to oxidation of hydrogen in the cathode –
- HFR and ex-situ characterization
 - High frequency resistant is monitored by impedance spectroscopy
 - EDX or chemical analysis can establish the presence of contaminants
 - Morphological changes are tracked via X-ray diffraction
 - SEM is used to monitor physical changes

General AST protocols for membranes

- Temperature and RH cycling → Thermal and Mechanical degradation
- Open circuit voltage → Chemical degradation
- Load cycling → Mechanical degradation
- Fenton's test → Chemical degradation
- Freeze/thaw cycling and sub-zero start-up → Mechanical degradation

DOE AST protocol for membranes

→ Chemical stability

Test Condition	Steady state OCV, single cell 25-50 cm ²
Total time	200 hours
Temperature	90°C
Relative humidity	Anode/cathode 30/30%
Fuel/Oxidant	Hydrogen/Air at stoics of 10/10 at 0.2 A/cm ² equivalent flow
Pressure, inlet kPa abs (bara)	Anode 250 (2.5), Cathode 200 (2.0)

→ H₂ cross-over and OCV

DOE AST protocol for membranes

→ Mechanical Cycle

Cycle	Cycle 0% RH (2min) to 90°C dewpoint (2min), single cell 25-50 cm ²
Total time	Until crossover > 10 sccm or 20,000 cycles
Temperature	80°C
Relative humidity	Cycle from 0% RH (2min) to 90°C dewpoint (2min)
Fuel/Oxidant	Air/Air at 2 slpm on both sides
Pressure	Ambient or no back-pressure

→ H₂ cross-over

AGENDA

- Quick introduction
- Membrane degradation
- **Electrode degradation**
- GDL degradation
- Bipolar plate degradation
- EU protocols
- Outlook



Mechanisms of electrode degradation

Causes	Effects
Sintering or dealloying of electrocatalyst	Loss of activation
Corrosion of electrocatalyst support	Conductivity loss
Mechanical stress	Decrease in mass transport rate of reactants
Contamination	Loss of reformate tolerance
Change in hydrophobicity of materials due to Nafion or PTFE dissolution	Decrease in water management ability

Mechanisms of electrode degradation

→ Platinum dissolution and particle growth in CL

- Results in the loss of electrochemically active surface area (ECSA)
 - A – Agglomeration of Pt particles on the carbon support
 - B – Dissolution in the ionomer and re-deposition on the surface of large particles → Ostwald ripening
 - C – Diffusion into the ionomer phase → precipitation in the membrane

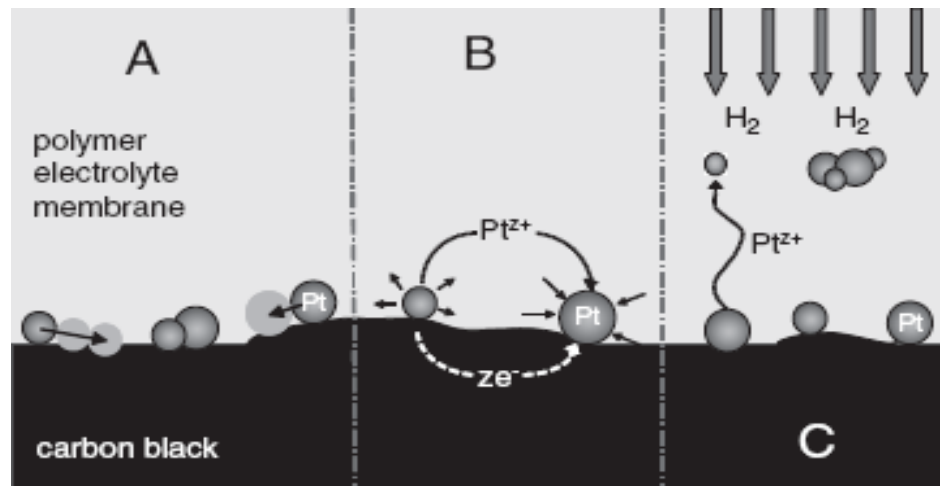

Felix N. Büchi, Minoru Inaba, Thomas J. Schmidt; Polymer Electrolyte Fuel Cell Durability; Springer 2009

Mechanisms of electrode degradation

→ Carbon oxidation (corrosion) in CL

- Carbon can be electrochemically oxidized to CO₂ at high potentials
- Two modes are believed to induce such a corrosion
 - Transitioning between startup and shutdown cycles
 - Fuel starvation due to the blockage of H₂ from a portion of the anode under steady state conditions

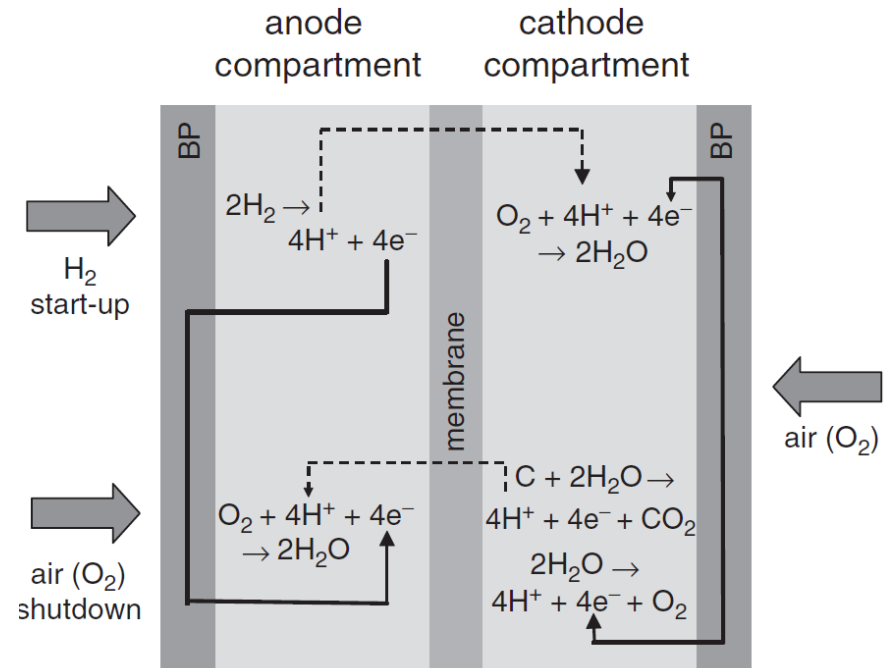
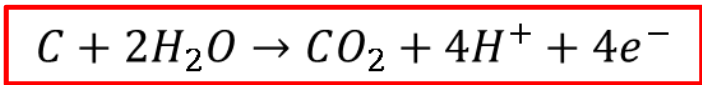

Felix N. Büchi, Minoru Inaba, Thomas J. Schmidt;
 Polymer Electrolyte Fuel Cell Durability; Springer 2009

Mechanisms of electrode degradation

→ Oxygen Evolution/Ionomer degradation in CL

- Presence of oxygen at the anode can result in serious damage once it reacts with hydrogen
- Ionomer in the electrode can degrade in a similar manner as that of the electrolyte membrane
 - Reduction in the ECSA
 - Effect on ionic and electronic conductivity of the electrode

Characterization of electrode degradation

- Electrochemical characterization
 - Cyclic voltammetry to monitor ECSA of the electrodes
 - EIS at (1-100 kHz) is used to determine the proton resistance of the electrodes
 - Polarization curves with various oxidants → limitation due to O₂
- Chemical analysis of effluents/Ex-situ characterization
 - Monitoring CO₂ by gas chromatography
 - ICP-MS or ICP-AES used to detect ionomer degradation
 - SEM and TEM to establish Pt particle growth/deposition
 - EDS/EDS, ICP-AES and XPS to study the chemical composition of the electrodes

General AST protocols for catalyst layers



RH cycling

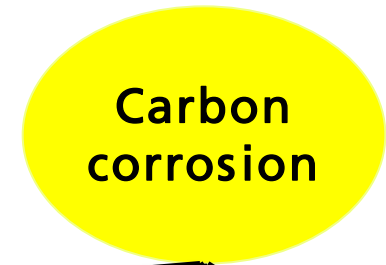

Cold start-up

Fuel starvation

Potential control

Start-up/shut-down cycles



Load cycling

Potential control

Temperature cycling

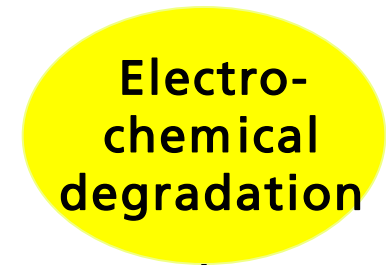

Contamination

DOE AST protocol

→ Electrocatalysts

Cycle	Step change: 30s at 0.7V and 30s at 0.9V. Single cell 25-50 cm ²
Number	30,000 cycles
Cycle time	60 s
Temperature	80°C
Relative humidity	Anode/Cathode 100/100%
Fuel/Oxidant	Hydrogen/N ₂
Pressure	150 kPa absolute

→ Polarization curve and ECSA

DOE AST protocol

→ Catalyst support

Cycle	Hold at 1.2 V for 24 h; run polarization curve and ECSA; repeat for total 200 h. Single cell 25-50 cm ²
Total time	Continuous operation for 200 h
Diagnostic frequency	24 h
Temperature	95°C
Relative humidity	Anode/Cathode 80/80%
Fuel/Oxidant	Hydrogen/Nitrogen
Pressure	150 kPa absolute

→ CO₂ release, Polarization curve and ECSA

Comparison of the individual figures with ECSA and X-over (always based on starting value) HFR

- DOE-catalyst support \rightarrow HFR decreases with current
- DOE-catalyst \rightarrow HFR change is very small
- Rectrangular \rightarrow HFR increases with increasing X-Over

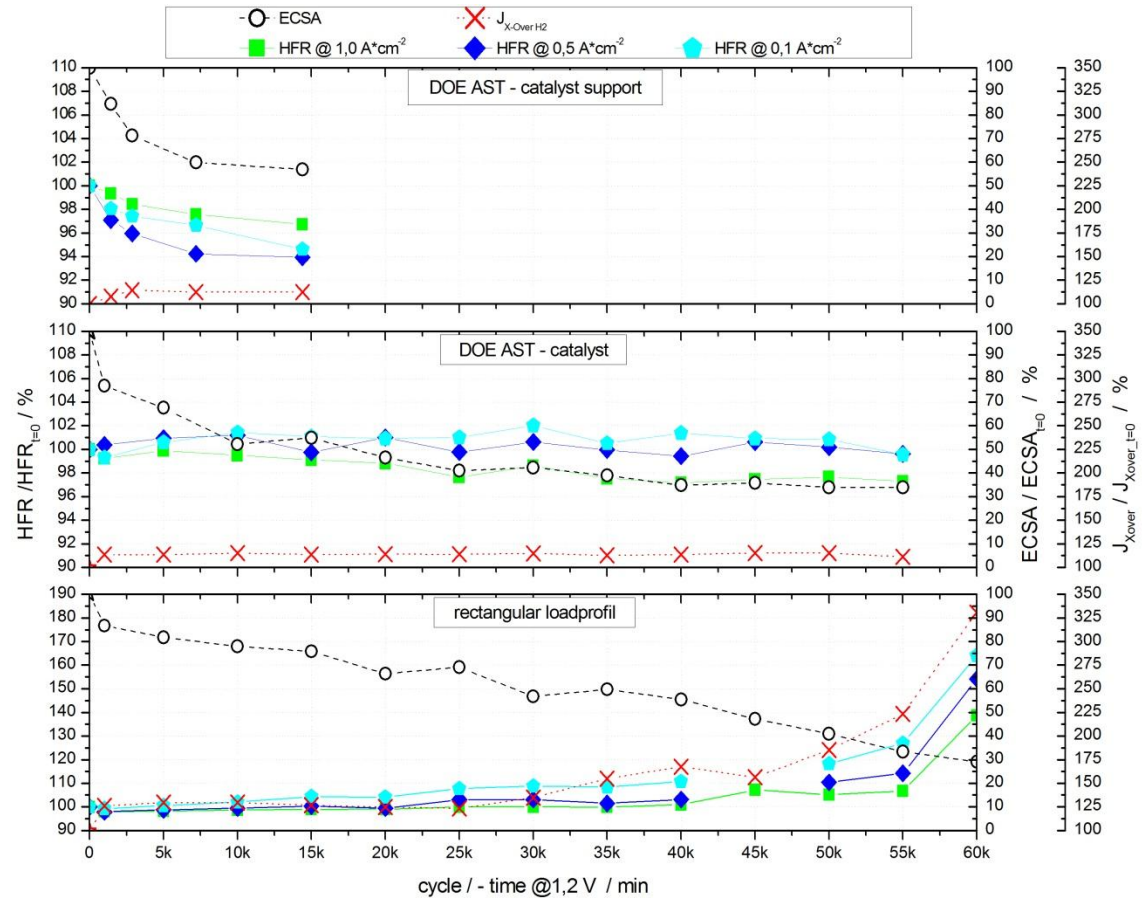

Courtesy of Christian Sadeler, Fraunhofer ISE

Comparison of the individual figures with ECSA and X-over (always based on starting value) Power

- Similar trends with DOE-catalyst support and DOE-catalyst
- Rectangular → towards the end, the power decreases due to crossover

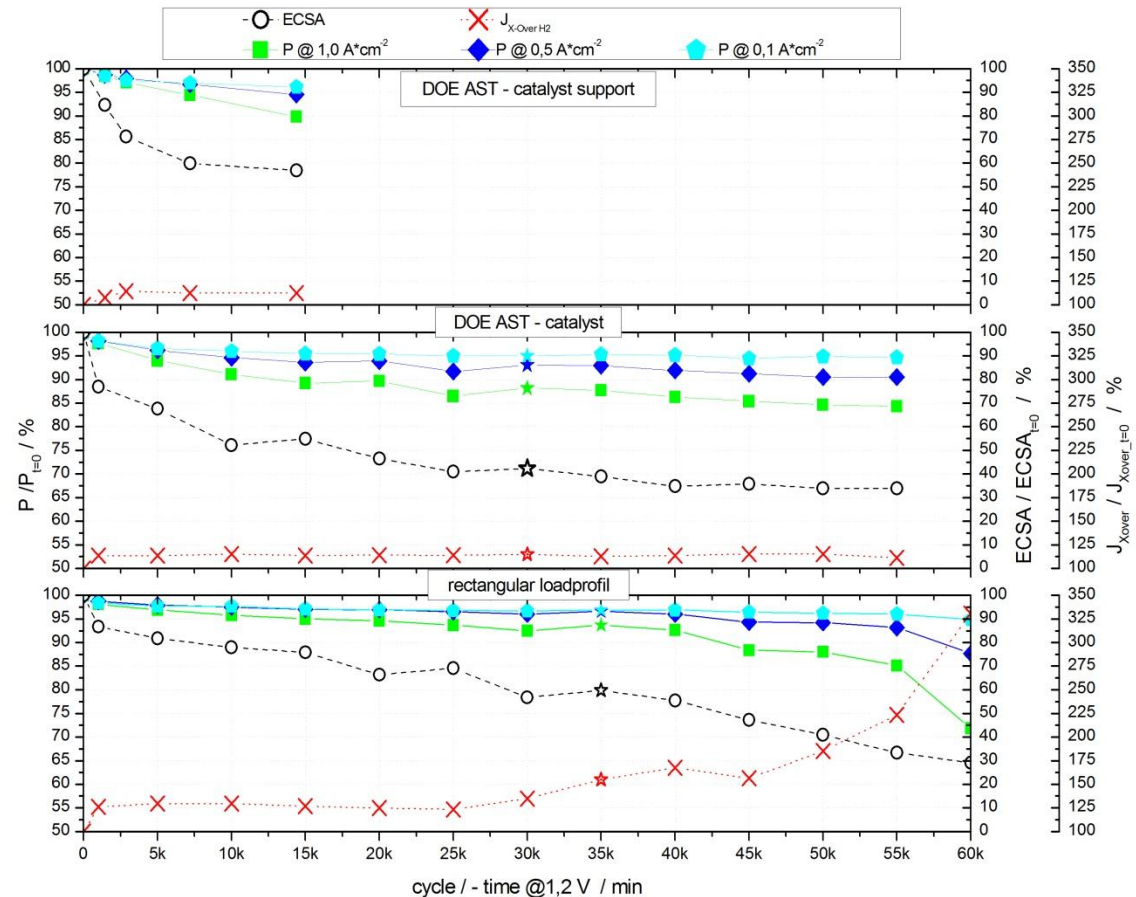

Courtesy of Christian Sadeler, Fraunhofer ISE

AGENDA

- Quick introduction
- Membrane degradation
- Electrode degradation
- **GDL degradation**
- Bipolar plate degradation
- EU protocols
- Outlook



Mechanisms of electrode degradation

→ Degradation of the GDL and MPL

- The carbon black in the MPL is not susceptible to electrochemical corrosion and contains no Pt to catalyze oxidation reactions
 - Chemical surface oxidation by water or even loss of carbon due to oxidation to CO or CO₂ may occur → reduction in hydrophobicity
- Decomposition of PTFE used as a binder is an issue → substantial effect on the water content of the GDL and MPL
- The GDL properties can also be changed by mechanical degradation as a result of the compression in the cell → GDL can be aged under compression strain which is correlated strongly with temperature

General AST protocols for GDLs

- In-situ stressors
 - Temperature cycling – change in hydrophobicity
 - Freeze/thaw cycling – GDL stability
 - Fuel starvation and high potential control – microstructural and characteristic changes
 - Hot pressing and high flow rates – induce mechanical degradation
- Ex-situ stressors
 - Submerging in hydrogen peroxide – accelerated mechanical failure
 - Immersing in liquid water at different oxygen concentrations and temperatures – change in hydrophobicity
 - Compression cycles

AGENDA

- Quick introduction
- Membrane degradation
- Electrode degradation
- GDL degradation
- Bipolar plate degradation
- EU protocols
- Outlook



Mechanisms of bipolar plate degradation

→ Corrosion

- Electrochemical reaction of metal with its environment to form oxides
- Membrane degradation is enhanced by corrosion of metallic bipolar plates
- Corrosion products from metallic bipolar plates impair durability of MEA
- Corrosion is influenced by
 - pH
 - Voltage
 - Temperature
 - Microstructure

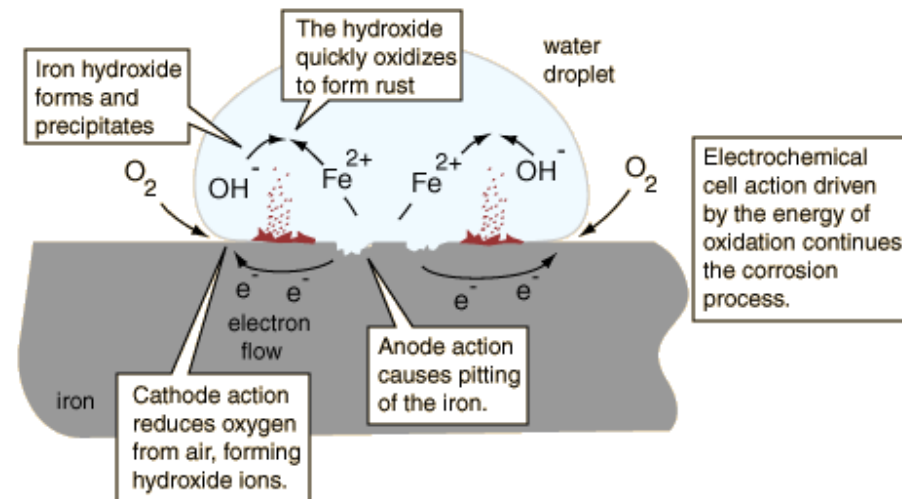

General AST protocols for bipolar plates

- Low temperature PEM (PFSA membrane)
 - 60 – 80°C
 - Bubbling air and oxygen or hydrogen
 - Electrolyte containing sulfate or fluoride ions
- High temperature PEM (PBI membrane)
 - 120 – 180°C
 - Air, oxygen or hydrogen
 - Phosphate containing electrolyte (85 % Phosphoric acid)
- → Ions contained in electrolyte are a result of degradation of the membrane

AGENDA

- Quick introduction
- Membrane degradation
- Electrode degradation
- GDL degradation
- Bipolar plate degradation
- **EU protocols**
- Outlook



EU protocol

- Four variables investigated
 - Dynamic Load Cycling Ageing
 - Long Term Durability Steady State
 - On/off Ageing Cycle
 - Humidification Sensitivity

EU protocol

→ Dynamic load ageing cycle test

- Load cycling measurement – to determine evolution of voltage with time
 - An initial U-I curve should be obtained
 - Fix current at $i_{load,max}$ for 10 minutes to stabilize the operating conditions before the start of the dynamic cycling
 - Low power stationary phase for 40 s at $i_{@20\%P_{max}}$ A/cm²
 - High power dynamic phase for 20 s with an increase from $i_{@20\%P_{max}}$ – $i_{@100\%P_{max}}$ A/cm²
 - U-I curves at fixed intervals for max.t/10: max.t=500-1000 h
 - Acceptance criterion should be defined with the equipment in mind
- Comparison of the final and initial polarization curves determines the aging level

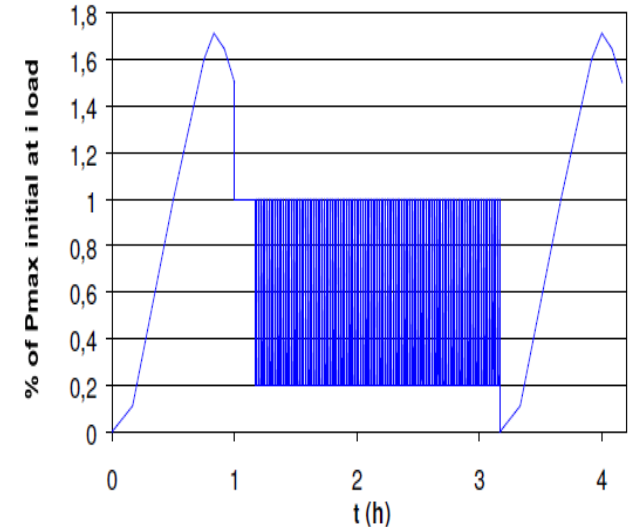
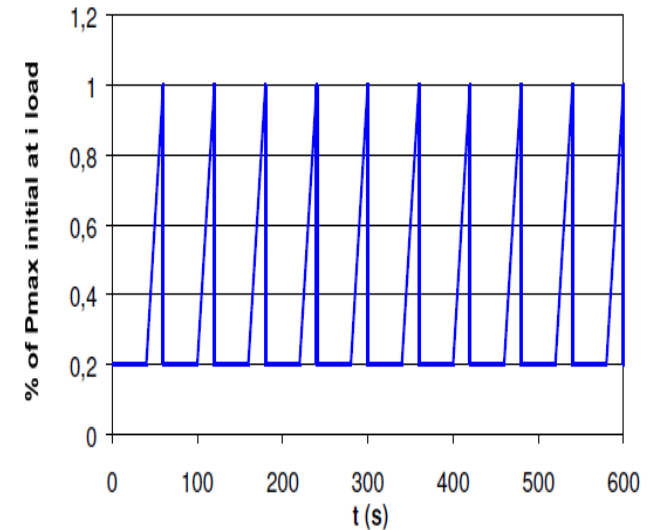

EU protocol

→ On/off ageing cycle

- **ATTENTION!!** Cell voltage **MUST** be stable before start of measurement – variation less than +/- 5 mV during the last hour before start
- Initial U-I curve – end criteria max current reached or cell voltage < 0.3 V
 - Other characterizations (EIS, voltammetry) are applied here
- On/off cycling – to determine the evolution of OCV and voltage as V/h when cell goes through “on”/“off” loads every 15 minutes at a certain load
- Increase the load current **SLOWLY**

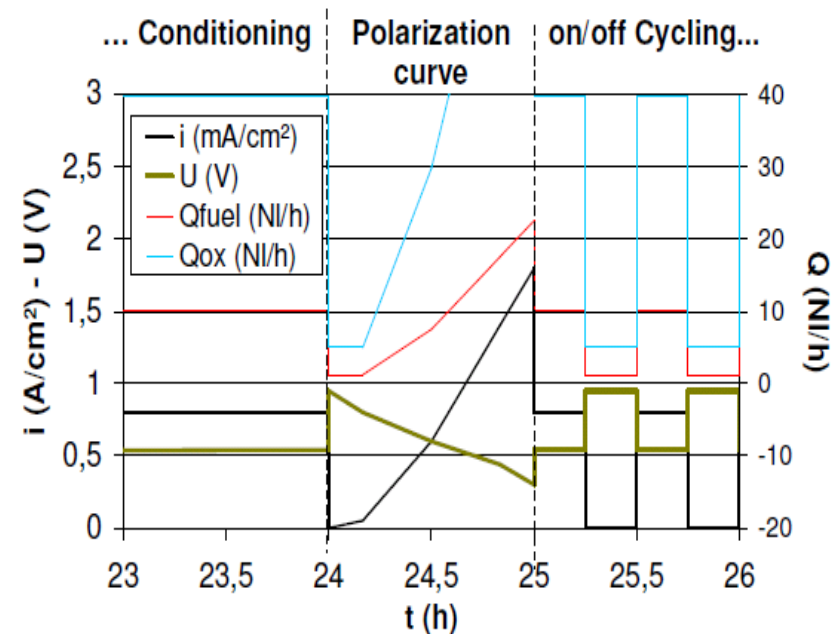

AGENDA

- Quick introduction
- Membrane degradation
- Electrode degradation
- Bipolar plate degradation
- EU protocols
- Outlook



CONCLUDING REMARKS

- Accelerated stress test protocols for PEM fuel cells are clearly identified and followed in literature
- DOE protocols are commonly used
- Key to AST is to be consistent and define the boundary conditions of the study before hand

Suggested reading

- F. A. de Bruijn, V. A. T. Dam, and G. J. M. Janssen. Fuel Cells 2008; 8:3-22.
- J. Wu, X.Z. Yuan, J.J. Martin, H. Wang, J. Zhang, J. Shen, S. Wu, W. Merida. J. Power Sources 2008; 184:104-119.
- X.Z. Yuan, H. Li, S. Zhang, J. Martin, H. Wang. J. Power Sources, 2011; 196:9107-9116.
- N. Yousfi-Steiner, P. Mocoteguy, D. Candusso, D. Hissel, A. Hernandez, A. Aslanides. J. Power Sources 2008; 183:260-274
- N. Yousfi-Steiner, P. Mocoteguy, D. Candusso, D. Hissel. J. Power Sources 2009; 194:130-145.
- AST protocols are constantly being improved:
 - http://www.hydrogen.energy.gov/annual_review12_fuelcells.html
 - http://www.hydrogen.energy.gov/pdfs/review10/fc015_madden_2010_o_web.pdf
 - http://www.hydrogen.energy.gov/pdfs/progress11/v_e_6_patterson_2011.pdf

Thank-you for your attention!

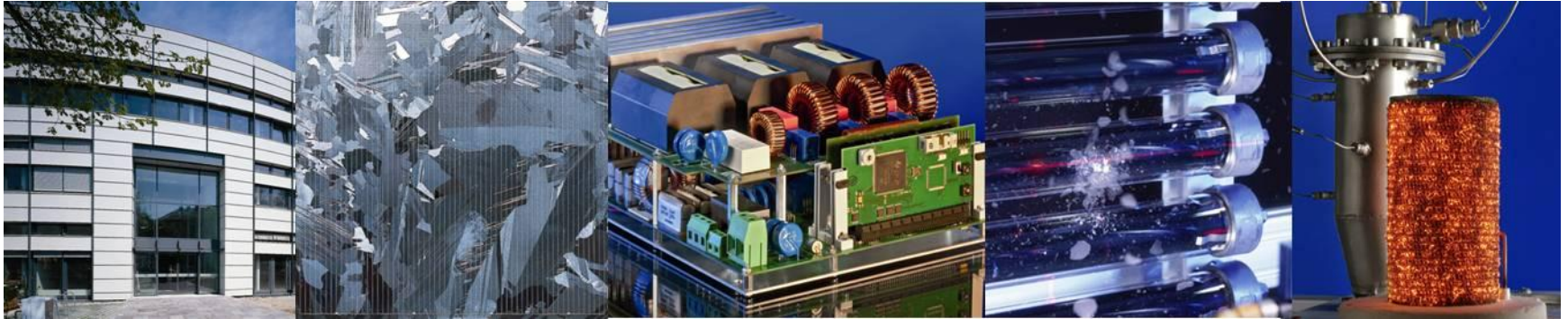

Fraunhofer Institute for Solar Energy Systems ISE

Nada Zamel

www.ise.fraunhofer.de

Mechanisms of bipolar plate degradation

→ Interfacial contact resistance and pitting corrosion

- Natural passivation
 - Passive film of corrosion products mitigate further corrosion
 - But increases the interfacial contact resistance between bipolar plate and GDL
- Passive film become unstable with increase in voltage
- Depletion of passive film leads to localised corrosion
 - Pitting corrosion
 - Crevice corrosion

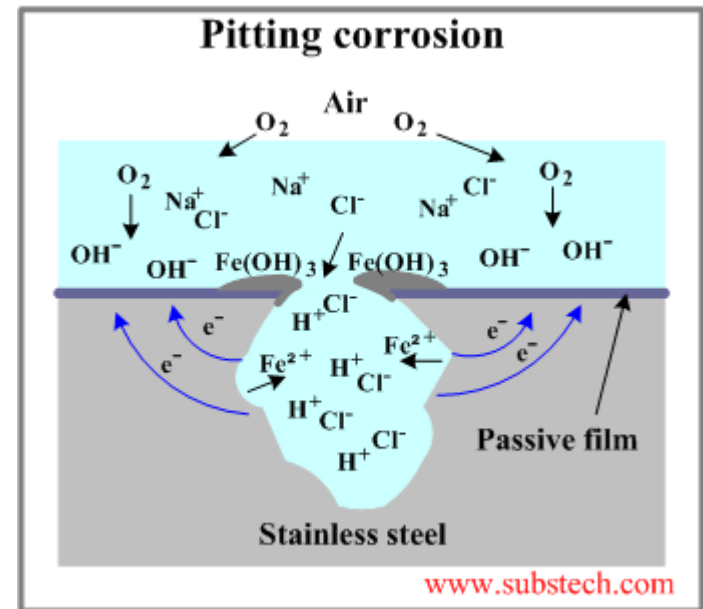

EU protocol

→ Polarization curve

- Measurement in galvanostatic mode starting at OCV
 - Current density steps or by a variable rate
 - Dwell time either a set value or depends on stability criterion

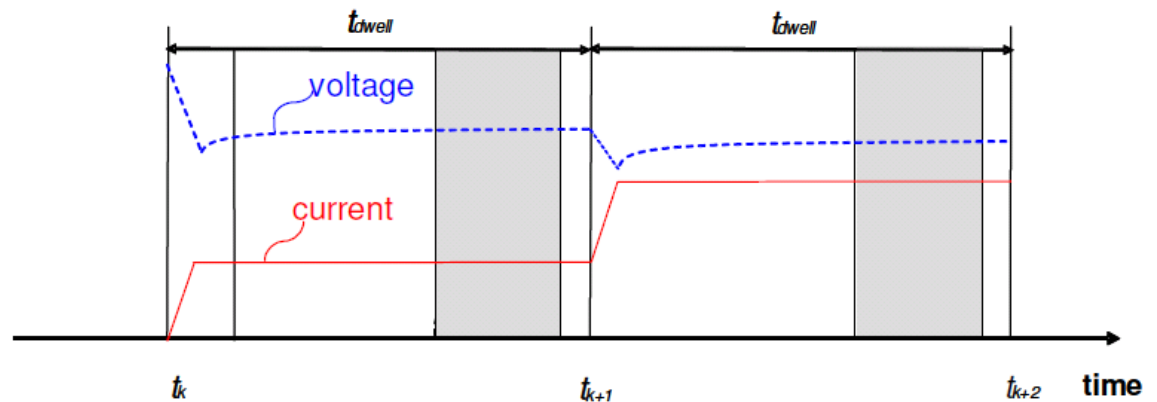
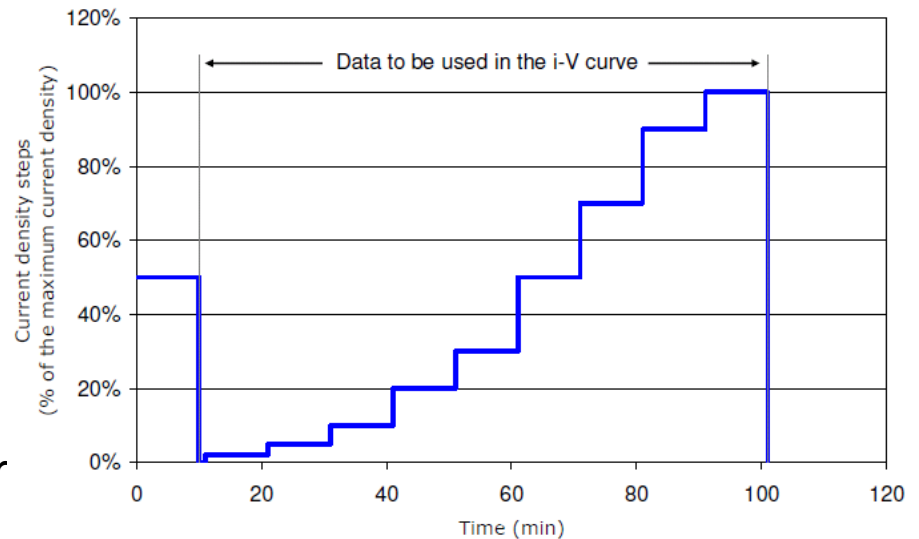

EU protocol

→ Humidification Sensitivity

- Quantify the sensitivity to relative humidity
- Cell is subjected to a sequence of steady test in specific environmental operating conditions
- Interest is in membranes, CL and GDL
- With this test, two variations are required – RH and current
- Steady state test lasts 2 hours until the variation in cell voltage < +/- 5 mV during the last 20 minutes

Humidification step n°	Fuel Relative Humidity	Oxidant Relative Humidity
1.	75%	25%
2.	75%	50%
3.	75%	75%
4.	50%	25%
5.	50%	50%
6.	50%	75%
7.	25%	25%
8.	25%	50%
9.	25%	75%
10.	0%	25%
11.	0%	50%
12.	0%	75%

Current density stage	Current density
(1)	800 mA/cm ²
(2)	600 mA/cm ²
(3)	400 mA/cm ²
(4)	200 mA/cm ²

EU protocol

→ Durability – steady state

- To determine the evolution of cell performance during a long term durability test
 - U-I curves plotted at specified conditions at various stages of the test
- To characterize PEFC components or sub-components of MEAs for research and development objectives
- To qualify the lifetime of PEFC components
- Long term durability steady state test – change the load at a time interval of $t_{\max}/10$ for a total time interval of 500 to 10,000 hours.
- Ending criteria when $V_{\text{end}} = 0.5\text{V}$ (if components are needed for further investigation); $V_{\text{end}} = 0.3\text{V}$ (if qualifying life time and degradation processes)