

STIG GEVING AND JONAS HOLME

# Compact wood frame roofs with built-in-moisture

Test house measurements of the drying potential and risk of mould growth

Project report 38

2009

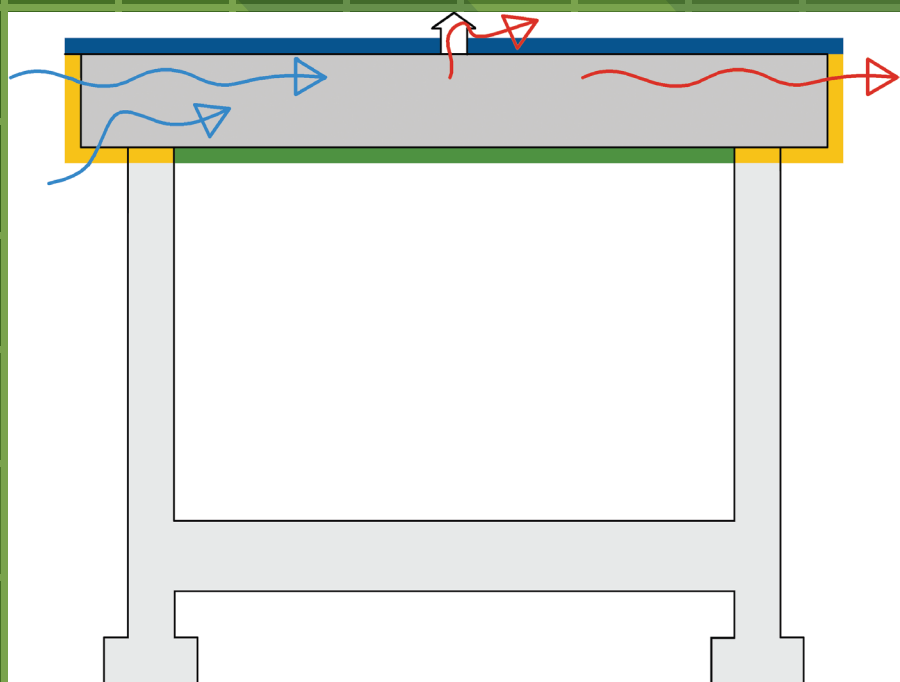

SINTEF Building and Infrastructure

Stig Geving and Jonas Holme

# **Compact wood frame roofs with built-in-moisture**

Test house measurements of the drying potential and  
risk of mould growth

Project report 38 – 2009

Project report no 38  
Stig Geving and Jonas Holme  
**Compact wood frame roofs with built-in-moisture**  
Test house measurements of the drying potential and risk of  
mould growth

Keywords: Roof, moisture, mould  
Emneord: Tak, fukt, byggfukt

Project no. B2175037

ISSN 1504-6958  
ISBN 978-82-536-1091-7 (printed)  
ISBN 978-82-536-1092-4 (pdf)

28 copies printed by AIT AS e-dit  
Content: 100 g scandia  
Cover: 240 g trucard

© Copyright SINTEF Building and Infrastructure 2009  
The material in this publication is covered by the provisions of the Norwegian Copyright Act. Without any special agreement with SINTEF Building and Infrastructure, any copying and making available of the material is only allowed to the extent that this is permitted by law or allowed through an agreement with Kopinor, the Reproduction Rights Organisation for Norway. Any use contrary to legislation or an agreement may lead to a liability for damages and confiscation, and may be punished by fines or imprisonment.

Address:      Forskingsveien 3 B  
                  POBox 124 Blindern  
                  N-0314 OSLO  
Tel:            +47 22 96 55 55  
Fax:            +47 22 69 94 38 and 22 96 55 08

[www.sintef.no/byggforsk](http://www.sintef.no/byggforsk)

# Contents

|   |           |
|---|-----------|
| <b>1. Introduction.....</b>   | <b>4</b>  |
| <b>2. Background .....</b>  | <b>5</b>  |
| <b>3. Method .....</b>  | <b>7</b>  |
| 3.1 Test house and field station.....                               | 7         |
| 3.2 Test roof elements.....   | 7         |
| 3.3 Hygrothermal measurements and built-in moisture.....            | 9         |
| 3.4 Improvements of drying potential.....                           | 11        |
| 3.5 Hygrothermal simulations.....                                   | 12        |
| 3.6 Mould inoculation and inspections.....                          | 13        |
| <b>4. Results and discussion .....</b>                              | <b>14</b> |
| 4.1 Hygrothermal measurements .....                                 | 14        |
| 4.2 Hygrothermal simulations.....                                   | 18        |
| 4.3 Mould observations.....   | 18        |
| <b>5. Conclusions.....</b>  | <b>22</b> |
| <b>6. References.....</b>   | <b>23</b> |
| <b>Appendix .....</b>   | <b>25</b> |
| Appendix 1 – Measured moisture contents in the plywood .....        | 25        |
| Appendix 2 – Measured moisture contents in the wooden rafters ..... | 28        |

# 1. Introduction

A typical flat or low-sloped compact roof has an insulation layer between the vapour barrier and a roofing membrane. The typical load bearing structure is a concrete or corrugated steel deck. Compact non-ventilated wood frame roofs, usually in the form of prefabricated elements, are also used to some extent. The drying potential of such unventilated constructions are normally limited. This makes this type of roof vulnerable for moisture during the construction period. The consequences may be microbial growth (mould and/or rot) on vulnerable materials such as wood. The drying potential may however be enhanced by certain measures.

Recent years it has been a high focus on possible negative health effects related to moisture in buildings. Mould growth has often been mentioned as one of the main negative factors in this respect. Even though one still has not managed to conclude what effects mould damages in buildings has on single individuals, it is established knowledge that there are an increased risk for health effects such as respiratory symptoms, asthma and allergy in both adults and children living in buildings with moisture related problems (Bornehag et.al., 2001 and Bornehag et.al., 2004). In this aspect there is a need for knowledge regarding what level of hygrothermal conditions gives mould growth on different materials and in different structures.

In this study the drying potential of various configurations of compact wood frame roofs with a high level of built-in-moisture has been investigated, through test house measurements and hygrothermal simulations. Roof elements has been wetted, and mould spores has been added to the elements. The hygrothermal conditions of the elements has been monitored through a period of 2 years, and the microbial conditions has also been registered.

The test house setup and mersurements has been carried out within the Norwegian research and development programme *Climate 2000 – Building constructions in a more severe climate*. The analysis work and reporting of the findings has been a part of the Norwegian research and development programme *CAB – Climate adapted buildings*. Both programmes have been financed by the Norwegian Research Council.

## 2. Background

Built-in-moisture in the insulation layer of a compact roof will generally dry out very slowly, compared to the drying rate in a ventilated roof construction. This is due to the roofing membrane and the vapour barrier having a high vapour resistance. Two-dimensional hygrothermal simulations of the drying potential of built in moisture by merely vapour diffusion of compact roofs were made in (Oustad et.al., 2005), using the computer programme WUFI 2D (Künzel, 1995). It was found that the drying potential over a three year period was limited, especially if a bitumenous membrane is used. A more vapour open membrane (e.g. PVC-membrane) and drying possibilities along the edges (eaves) of the roof may however speed up the drying.

It has however been observed that built-in-moisture in compact roofs may dry out at a higher rate than what is expected by vapour diffusion alone, e.g. see (Noreng et.al., 2005) were 12 compact roofs with documented accumulation of moisture during construction period were followed up two and four years later. Hygrothermal simulations by Noreng et.al., (2005) suggested that the drying potential of built-in-moisture in compact roof could be between 20 and 120 g/m<sup>2</sup>year with single-layer bituminous roof covering and PVC-roofing respectively. These simulations however only included one-dimensional water vapour diffusion, i.e. not including drying along the edges or air leakages. The measured drying was however considerably higher than this low level, and this was explained by other transport mechanism than diffusion being important. Such transport mechanisms could be wind pressure induced air leakages, for instance with outdoor air flowing into the insulation layer at one edge of the roof and out at the opposite edge of the roof. Drying of the roofs due to such air leakages occurs mainly when solar radiation warms the roof or in the summer when the outdoor temperature is high enough to allow the air to contain a lot of water vapour. The outer part of compact roofs may experience temperatures between 50-60 °C during the middle of a clear and sunny day, allowing for high moisture contents in the flowing air. The air flow through the insulation layer may also go through possible openings in the roofing (e.g. installed ventilation louvres), all contributing to the drying.

Salonvaara and Nieminen (2002) reported very positive effect on the drying potential of built-in-moisture when using rigid mineral wool with small ventilation grooves, i.e. small channels where outdoor air may flow from one side of the roof to the other side or to special breather vents in contact with the insulation layer. The ventilation grooves investigated typically had a geometry of 20 x 50 mm cc 200 mm, and they were connected to breather vents by connecting channels. The ventilation grooves were covered by a layer of 20 mm rigid mineral wool below the roofing membrane. Results from field testing showed ventilation rates that varied typically between 0,005 and 0,1 m<sup>3</sup>/m<sup>2</sup>h depending on the ventilation details, size of the ventilated area and location of the roof and building. An airflow rate of approximately 0,1 m<sup>3</sup>/m<sup>2</sup>h was found adequate to allow for drying of typical levels of built-in-moisture during one summer. Another study of ventilation grooves in the mineralwool in compact roofs are given in (Paukstys et.al., 2007), also showing a positive effect in regard to moisture removal.

A theoretical study of all the possible drying mechanisms for compact roofs are given in (Uvsløkk, 2008). It was generally concluded that air leakages of outdoor air flowing from one side of the roof through the insulation layer and out at the other side of the roof (and possibly supplied with ventilation louvres in the middle of the roof), is the mechanism with largest potential for drying of built-in-moisture. The potential was found to be largest when the insulation layer has small ventilation grooves, such as described above.

The possible positive effect of intended or unintended drying by leakages of outdoor air through the insulation layer is further investigated in this article.

Most compact roofs are made of predominantly non-organic materials with a relatively high resistance against microbial growth. The field study of Noreng et.al. (2005) showed relatively small amounts of mould growth in compact roofs with only non-organic materials, even for roofs where the wetting of the insulation layer during construction were reported to be “very serious”. For lightweight wood frame roofs the situation however is different. The wooden materials used in such constructions are highly susceptible for microbial growth. As a consequence such constructions must be even better protected from moisture during construction and user phase. This article investigates the microbial growth occurring in such compact wood frame roofs, for a relatively high level of built-in-moisture.

Microbiological growth may appear on almost every material exposed to moisture. The humidity exposure may be caused by water supply/leakage or by high air humidity. Microbiological growth may appear both on organic materials (wood, textile, cardboard etc.) (Nielsen et.al., 2004) and on inorganic materials (concrete, clay brick, natural stone etc.) settled by organic compounds (Viitanen, 2004). In a compact wood frame roof the materials are wood and thermal insulation. Mould growth on building materials are dependent of the moisture content, temperature and the nutrient available. In a review concerning the moisture and temperature limits for mould growth, mould was detected on wood placed in an environment with 78% relative humidity and a temperature of 25°C. Mould growth was registered at temperatures down to 5°C, but then with a RH between 87-98%. At temperatures above 40°C there was no growth (Jansen and Myklebust, 2007). In insulation material such as glass wool and mineral fiber, some studies report mould growth at RH levels above 96%, and temperatures higher than 20°C (Foarde et. al., 1996).

## 3. Method

### 3.1 Test house and field station

The test house is located on a field station belonging to the SINTEF Building and Infrastructure and the Norwegian University of Science and Technology (NTNU). The field station is located on an open field in Trondheim. The exact location is N63°25' E10°28'.

The indoor air temperature are controlled at a level between approximately 16-21 °C. During summer the temperature might get higher in periods. The test house is not ventilated or humidified, so the RH is allowed to fluctuate depending on mainly the outdoor temperature and RH. Both the indoor air temperature and RH are logged every hour.

Outdoor climatic data are measured by a Milos 500 Vaisala automatic weather station (AWS) located 17 m to the south of the test house. The AWS is operated by the Norwegian Meteorological Institute in cooperation with SINTEF Building and Infrastructure, ensuring a good quality of the measurements. Average climatic data for 2007 is given in table 1.

Table 1

Monthly averages during 2007 for the temperature inside of the building (T in), temperature and relative humidity (RH) outside, global radiation, wind speed and wind direction. All data are calculated from hourly averages through the month. Wind direction is presented as the percent share of time for each direction (8 fold scale) during the month.

|                  | T in | T out | RH out | Global radiation    | Wind-speed | Wind direction |    |   |    |    |    |    |    |
|------------------|------|-------|--------|---------------------|------------|----------------|----|---|----|----|----|----|----|
|                  | (°C) | (°C)  | (%)    | (W/m <sup>2</sup> ) | (m/s)      | N              | NE | E | SE | S  | SW | W  | NW |
| <b>January</b>   | 16,5 | -0,5  | 79,7   | 4,0                 | 3,2        | 2              | 7  | 5 | 3  | 36 | 33 | 9  | 4  |
| <b>February</b>  | 16,5 | -4,0  | 71,0   | 30,9                | 2,5        | 33             | 8  | 6 | 4  | 29 | 17 | 3  | 0  |
| <b>March</b>     | 16,8 | 3,5   | 68,1   | 74,1                | 2,7        | 2              | 12 | 4 | 6  | 32 | 34 | 7  | 3  |
| <b>April</b>     | 17,0 | 4,8   | 73,1   | 104,0               | 3,6        | 3              | 6  | 3 | 3  | 13 | 38 | 27 | 8  |
| <b>May</b>       | 17,4 | 8,2   | 69,6   | 150,0               | 2,5        | 8              | 19 | 7 | 4  | 13 | 26 | 10 | 13 |
| <b>June</b>      | 20,5 | 14,1  | 60,3   | 223,6               | 2,3        | 7              | 23 | 7 | 3  | 13 | 19 | 11 | 17 |
| <b>July</b>      | 20,9 | 15,7  | 70,4   | 178,1               | 2,3        | 6              | 26 | 9 | 6  | 12 | 17 | 14 | 10 |
| <b>August</b>    | 18,9 | 13,4  | 76,8   | 125,5               | 2,3        | 6              | 20 | 9 | 3  | 16 | 26 | 12 | 8  |
| <b>September</b> | 17,2 | 8,6   | 75,4   | 71,3                | 2,9        | 2              | 9  | 5 | 5  | 22 | 38 | 14 | 5  |
| <b>October</b>   | 17,1 | 6,0   | 81,9   | 31,7                | 2,4        | 3              | 10 | 4 | 2  | 26 | 43 | 10 | 2  |
| <b>November</b>  | 17,0 | 1,0   | 84,4   | 7,1                 | 2,8        | 3              | 8  | 5 | 2  | 28 | 40 | 10 | 5  |
| <b>December</b>  | 17,0 | 0,2   | 78,6   | 2,3                 | 2,6        | 0              | 2  | 6 | 6  | 30 | 54 | 1  | 1  |
| <b>Average</b>   | 17,7 | 5,5   | 73,9   | 77,5                | 2,7        | 6              | 12 | 6 | 4  | 24 | 32 | 10 | 6  |

### 3.2 Test roof elements

Five different roof elements are included in this investigation. The overall dimensions of the roof sections are 1190 mm x 4750 mm, as shown in figure 1. The roof sections span from facade to facade, and have a 1:40 slope. A PE-foil isolate the roof section perimeter from the surrounding sections in terms of mass transfer, and adiabatic conditions were maintained at the test section perimeter with respect to heat transfer.

In one of the timber frame roof sections (R5) the rafter spacing is 1.2 m to achieve 1-dimensional conditions in the middle of the section, while the other four timber frame roofs (R1-R4) have a more normal 0.6 m rafter spacing. In section R5 the wooden rafters are separated from the rest of the section with a polyethylene foil (see Figure 1b).



One element (R1) has a dark coloured roofing membrane (solar absorption factor  $\approx 0.9$ ), while the other four have the same roofing membrane, but the light coloured side facing upwards (solar absorption factor  $\approx 0.65$ ).

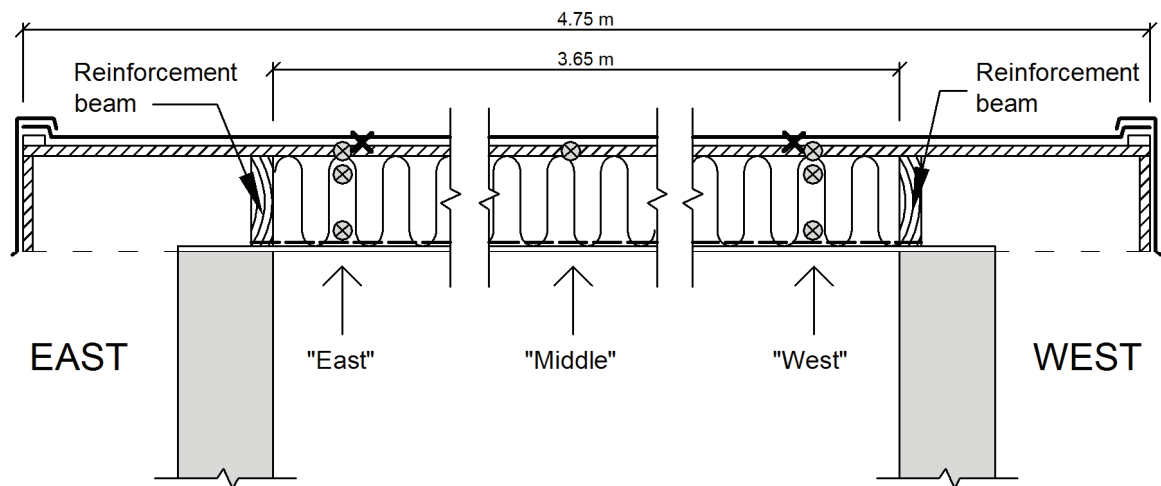

- ⊗ Location of thermocouples and MC sensors in plywood and rafters
- ⊗ Location of thermocouples at surfaces (roofing membrane/plywood and interior surface)

a. Cross section east- west

**Elements R1, R2, R3 & R4:**

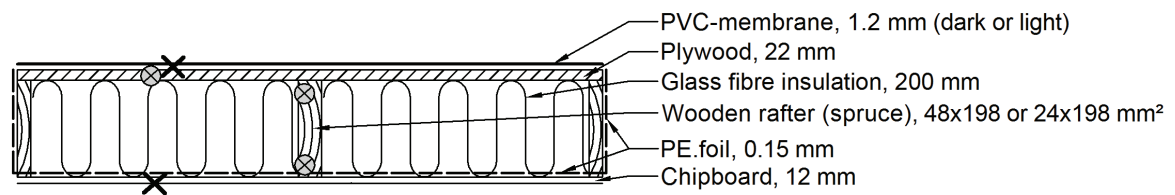

**Element R5:**

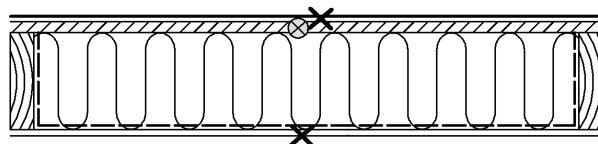

b. Cross section north - south

Figure 1  
The framework of the timber frame roof sections, with measurement points. The dimensions of the figure are not in scale. See also figures 2, 3 and 5.

The plywood roof boards are made of spruce or pine (with seven layers) and a density of  $411 \text{ kg/m}^3$ . The rafters are made of Norway spruce (*Picea abies*) with a density ranging from  $350 - 465 \text{ kg/m}^3$ . The glass fibre insulation are mounted in two layers of 100 mm and has a density of  $18 \text{ kg/m}^3$ .

The most important material properties necessary to analyze the hygrothermal behaviour of the roof sections are probably the water vapour permeability (or vapour resistance) and the hygroscopic sorption curves. These two properties have been measured for most of the materials used in the constructions in the test house, and the results are presented in table 2 and 3. A more detailed presentation of these measurements and results are given in (Bergheim et.al, 1998).

Table 2

Measured water vapour permeance (with standard deviation  $\sigma$ ) and corresponding equivalent air layer thickness. Average RH-level during measurements was 72 % (50%/94%).

| Material                          | Thickn. | Density              | Water vapour permeance $\pm \sigma$   | Equivalent air layer thickness        |
|-----------------------------------|---------|----------------------|---|---------------------------------------|
|                                   | mm      | (kg/m <sup>3</sup> ) | (10 <sup>-12</sup> ·kg·m <sup>-2</sup> ·Pa <sup>-1</sup> ·s <sup>-1</sup> ) | (S <sub>d</sub> ) $\pm \sigma$<br>(m) |
| Plywood                           | 22      | 411                  | 145 $\pm$ 10  | 1.34 $\pm$ 0.10                       |
| Polyethylene foil, vapour barrier | 0.15    |                      | 3.09 $\pm$ 0.57   | 63.0 $\pm$ 14                         |
| PVC roofing membrane              | 1.3     |                      | 15.0 $\pm$ 1.1  | 13.0 $\pm$ 1.0                        |

Table 3

Measured equilibrium moisture contents (weight-%) for adsorption and desorption curves for plywood and spruce (rafters).

| RH (%) | Plywood |         | Spruce |         |
|--------|---------|---------|--------|---------|
|        | Ads.    | Des.    | Ads.   | Des.    |
| 11.3   | -       | 3.8     | -      | 3.1     |
| 32.9   | 6.8     | 8.3     | 7.2    | 7.8     |
| 53.5   | 8.9     | 10.3    | 9.6    | 10.0    |
| 75.4   | 12.2    | 14.8    | 13.2   | 14.7    |
| 81.2   | 13.2    | -       | 14.1   | -       |
| 94     | 17.8    | -       | 18.6   | -       |
| 97.4   | 18.9    | (18.9)* | 21.0   | (21.0)* |

\*The desorption curve started at the endpoint of the adsorption curve.

### 3.3 Hygrothermal measurements and built-in moisture

#### Measurement set-up

The moisture content of the wooden rafters and the plywood boards was measured by traditional pin electrode resistance measurements. The distance between the two steel pins was 25 mm. The diameter of the metal electrodes used was 2 mm. The electrodes were covered with plastic except for 10 – 15 mm at the tip giving the measurement area embedded in the plywood, see figures 2 and 3. The locations of the measurement points in the roof sections are shown in figure 1. The measurements were conducted during the 2-year period 01.01.2007 - 31. 12. 2008

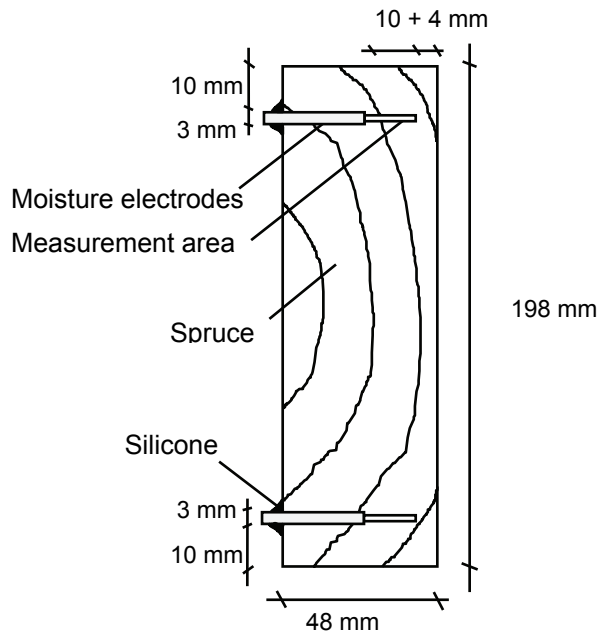

Figure 2  
Detail of the rafter in a timber frame roof section showing location of two pairs of moisture electrodes.

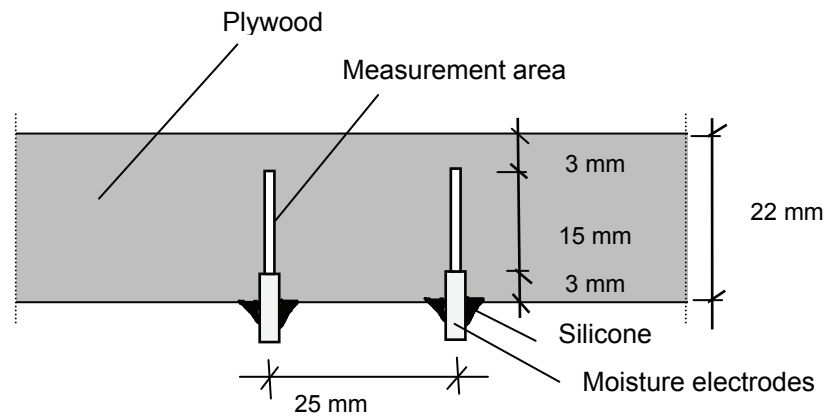

Figure 3  
Detail of plywood in timber frame roof section showing location of a pair of moisture electrodes.

### Accuracy of measurements

The measurements were adjusted according to wood species and temperature. The measurement range is normally set to 7-25 % by weight. The accuracy of resistance measurements are discussed in Apneseth and Hay (1992). The measurement accuracy depends generally on three factors:

- systematic errors in the measurement apparatus
- material related measurement errors (i.e. there are not 100% correlation between resistance and moisture content)
- accidental errors

For our measurements we neglect the effect of systematic errors in the measurement apparatus and logging system. The material related errors varies with wood species, and increases with increasing moisture content. In Du et.al. (1991) the following 95% confidence interval ( $\pm 1,96 \cdot \sigma$ ) was found for one single measurement on spruce:

Table 4

Measurement uncertainty for resistance measurements on spruce (Du et al., 1991).

| Wood moisture content (weight%):                     | 7%         | 12%        | 18%        | 25%        |
|--|------------|------------|------------|------------|
| 95% confidence interval ( $\pm 1,96 \cdot \sigma$ ): | $\pm 0,37$ | $\pm 0,65$ | $\pm 1,21$ | $\pm 2,09$ |

The measurement method with the given electrode setup and measurement sequence (calibration curves, temperature compensation, wood species compensation) is described in (Geving and Uvsløkk, 2000), and was also controlled by gravimetric measurements in that study. The gravimetric measurements showed very good accordance with the resistance measurements, well within the 95% confidence interval showed in table 4.

For the plywood resistance measurements the same wood species calibration curve as for the rafters was intended used (i.e. spruce), since the plywood also consisted of spruce. A control by using the gravimetric method showed however a large discrepancy between real moisture content and that measured by the electrical resistance method, i.e. the measured values were larger than the real values. The differences were small at low moisture contents but increasing as the moisture content increases. The difference between the electrical resistance method (calibration curve for spruce) and the gravimetric measurements are shown in figure 4. For the moisture content of the plywood presented further on in this article the values measured by the electrical resistance method are corrected according to figure 4.

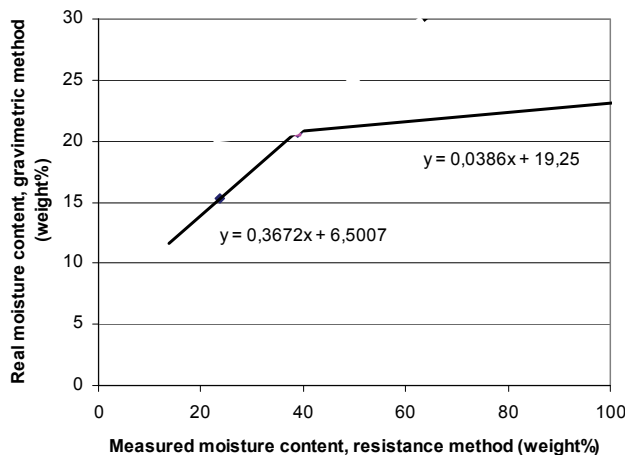

Figure 4

Relationship between measured moisture content in plywood boards by the electrical resistance method (using standard calibration curve for spruce) and the real moisture content measured as a control using the gravimetric method.

### Application of built-in-moisture

Moisture was added through a conventional garden irrigation hose (micro-drip-system), that were mounted on the inner side of the plywood boards, see figure 6. A total of 17.2 litres was added in each test house element divided at three separate times with one week apart, so that the water should have some possibility to redistribute within the construction between each water insertion. The first time was on the 23 of February 2007. This water content of 17,2 litres is equivalent to a water-film of 4 mm in the element.

## 3.4 Improvements of drying potential

It is known that moisture in compact flat roofs may dry by several different mechanisms. Often the 1-dimensional vapour diffusion through the roofing or vapour barrier have been considered the main mechanism. To investigate the effect of the two-dimensional vapour diffusion and air leakage/ventilation through the eaves various modifications were conducted at the roof elements, as shown in figure 5. For all elements except R3 the bottom part of the eaves (cornice) were left

open, to increase the possibility for air leakage/ventilation through the insulation layer of the elements and sideways vapour diffusion. For R4 and R5 there were also in addition drilled a few holes through the reinforcement beam hereby ensuring the possibility for air leakage of outdoor air through the insulation layer during windy conditons. The drilled holes have an area equivalent to approximately 1 mm continuous opening along the edge of the roof.

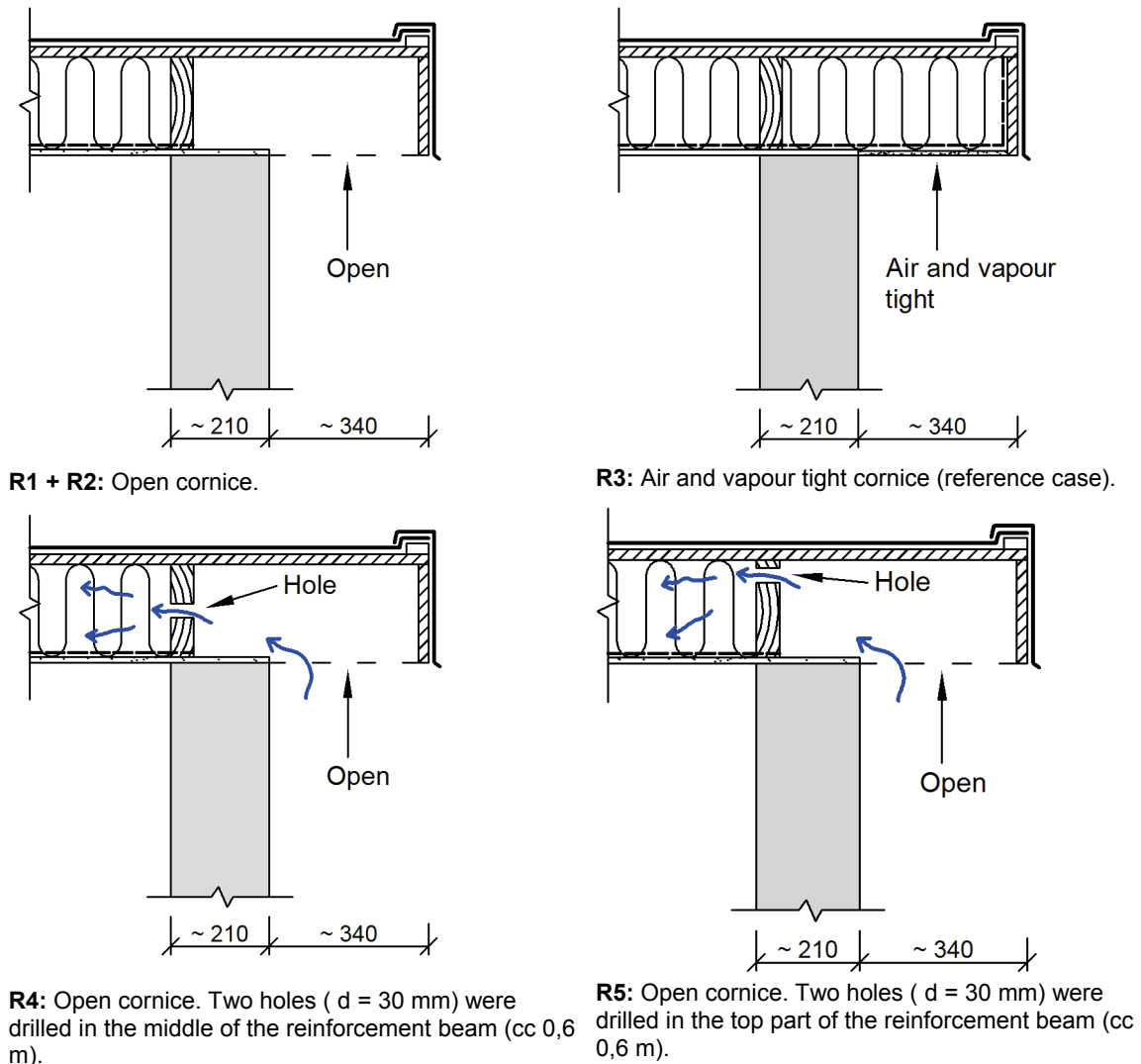

Figure 5  
Description of drying improvements applied for the various roof sections. The sketch show a cross section of the roof overhang at the western and eastern side of the test house.

### 3.5 Hygrothermal simulations

Hygrothermal simulations of the roof elements were performed using the numerical software WUFI 1D Pro (Künzel, 1995). WUFI 1D Pro is a commercial software designed to calculate realistic hygrothermal processes. It includes transient one-dimensional coupled heat and moisture transport, and considers both vapour diffusion and capillary conduction. The main scenario that is considered in the simulations is the effect of horizontal air leakages through the reinforcement beams (with holes) and the insulation cavity.

Although being one-dimensional, WUFI 1D Pro includes the possibility of adding a user defined air change source (coupled to the outdoor air) to a certain material layer. WUFI calculates the heat and moisture source due to the defined air change rate, using the outdoor air temperature and

humidity as boundary conditions. The air change rate was varied between 0,1-0,5 1/h, that equals a ventilation rate of 0,02 – 0,1 m<sup>3</sup>/h per meter width of the roof. This coincide with the typical ventilation rates reported by Salonvaara and Nieminen (2002) when using rigid mineral wool with small ventilation grooves. The air leakage was evenly spread through the whole insulation layer.

A two-year simulation was performed using climatic data from Trondheim. It should however be mentioned that it was not climatic data from the same years as the measurement period, so the measurements and the simulations are not directly comparable. Otherwise the inputdata were chosen so as to simulate the roof elements as good as possible. Material data was chosen from table 2 and 3, otherwise it was chosen from WUFI's database. The built-in-moisture was added to the insulation layer. The simulations were performed with the light coloured membrane (solar absorption factor  $\approx 0.65$ ).

### 3.6 Mould inoculation and inspections

Each roof element was inoculated with a mould spore suspension containing 1 million spores per Millie litre. The spores were from the specie *Penicillium Chrysogenum*. The suspension was sprayed in the middle (500 mm  $\times$  500 mm) on the internal side of the plywood. The plywood moisture content sensor in the middle part of the element was in the middle of the sprayed area.

Inspection of the inside of the elements was conducted three times (17.07.07, 20.09.07 and 26.11.07). The internal chipboard, polyethylene foil and mineralwool were demounted for the inspections, and remounted within an hour to prevent drying of the materials. The demounted area was in the middle part of each element (1,2 x 0,6 m), se figure 6, covering more than the mould inoculated area. Visible mould growth was registered visually and by digital photo.

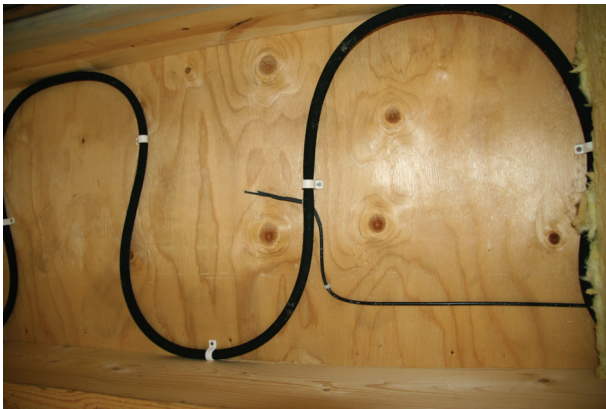

Figure 6  
Inspection of the roof element no. 1 from the inside. The internal chipboard, polyethylene foil and mineralwool were demounted. The garden irrigation house and the moisture content sensor in the middle part of the element can be seen. There were very little visible mould growth.

## 4. Results and discussion

### 4.1 Hygrothermal measurements

All the moisture measurements are given in diagrams in Appendix 1 (plywood) and Appendix 2 (wooden rafters). The most important results are however presented in this chapter.

The moisture conditions of the plywood show a strong dependency of the degree of ventilation of the roofs. This can particularly be seen for the roof elements R4 and R5 where special ventilation holes were drilled through the reinforcement beam, see figure 6 - 8. During the first summer it seems that most of the added moisture has dried out, while in comparison there is no net drying of element R3 (being air and vapour tight at the roof overhang) during the first year. It also seems to be an effect of only opening the bottom part of the cornice as was made for elements R1 and R2, compared to element R3, see figure 6 - 8. This effect could be due to unintentional ventilation, i.e. the discontinuous reinforcement beam will never be total air tight at the joints against the continuous element rafters. In addition there will probably also be an effect of sideways water vapour diffusion through the reinforcement beams, since there is no vapour barrier in the bottom part of the cornice (as it is in element R3).

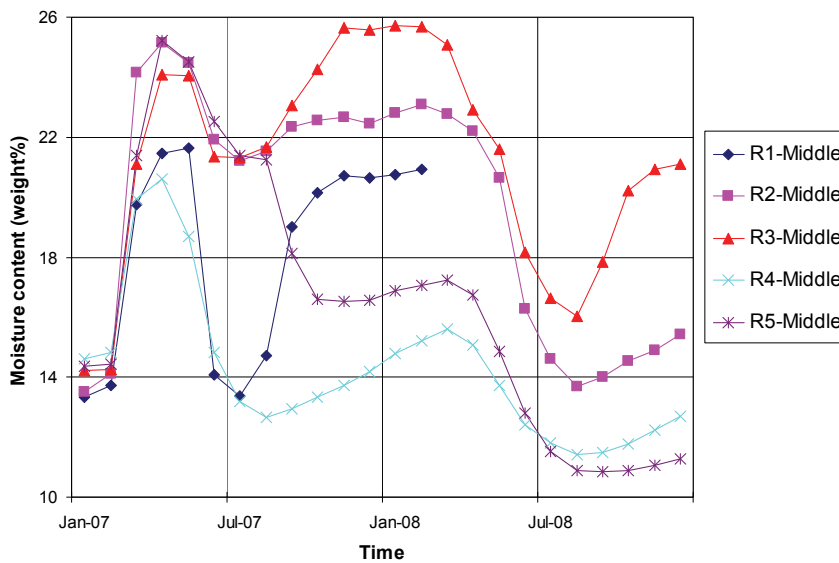

Figure 6  
Moisture content in the plywood (middle part) for all five roof elements. The measured values for R1 is not shown after February 2008, due to a water leakage through the roofing membrane occurring at that time.

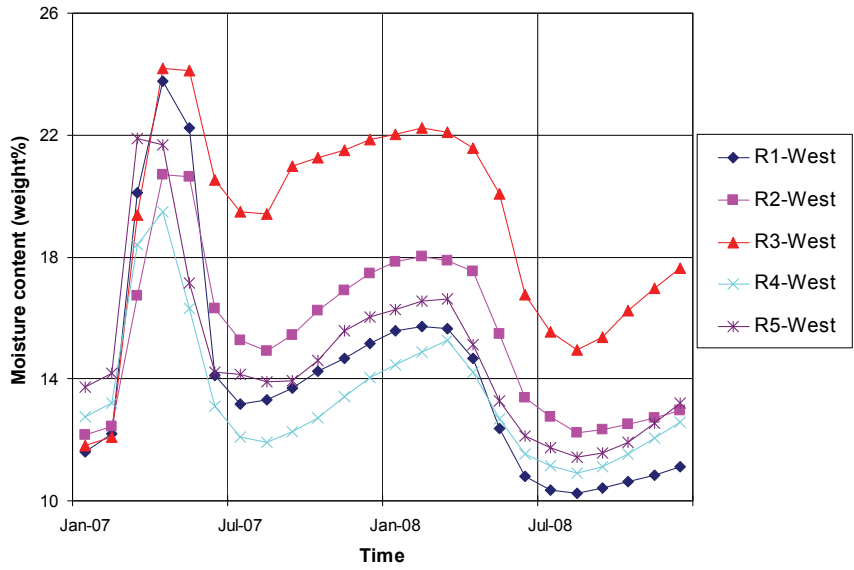

Figure 7  
Moisture content in the plywood (western part) for all five roof elements.

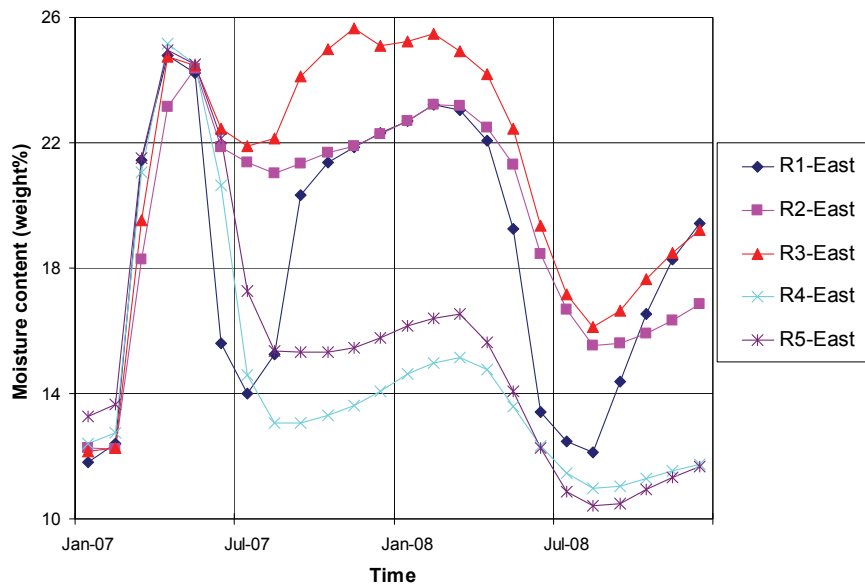

Figure 8  
Moisture content in the plywood (eastern part) for all five roof elements.

Figure 6 - 8 show a higher moisture content of the plywood in R5 compared to R4, and that the drying during summer is much slower. Although the holes through the reinforcement beam were drilled in the top part for R5 and the middle part for R4 as shown in figure 5, it seems unlikely that this can explain the slower drying for R5. A more likely explanation is that the rafters in R5 are separated from the insulation cavity with a polyethylene foil, i.e. the only material with any significant moisture capacity in the element R5 is the plywood. With the same amounts of built-in-moisture in both elements we can assume that the plywood in R5 both will take up a higher initial moisture content (since there are no rafters to absorb any moisture). In addition the inward drying during summer will also have smaller effect, since there are no wooden materials to absorb any of the moisture diffusing inwards during a sunny day (i.e. more of the moisture will be transported back to the plywood during the nighttime).



For all the elements we can observe that the plywood on the western side of the roof element dries much faster than the middle and eastern part of the element, see example in figure 9 and 10. The difference between the middle and eastern part of the elements are however not big, except for element R4 where the eastern side has a significant lower moisture content the first half year of the period. The faster drying of the western side also applies for the rafters, when comparing the moisture content of the western and eastern side (there were no measurements on the rafters in the middle part of the elements), see figure 11. This effect is however most pronounced in the measurement point in the outer part of the rafters. The most possible explanation of this difference of drying rate between western and eastern side of the elements, is that the dominating wind direction is from south-west, see table 1. The wind direction is between south-west and north-west 48% of the time, while it is between north-east and south-east only 24% of the time. This means that the air leakages into the roof elements from outside more often will enter the roof cavity from the western side (and leave the roof on the eastern side), than the opposite. While the air moves through the roof elements, the air will take up moisture from the roof cavity, and its capacity to absorb moisture will decrease.

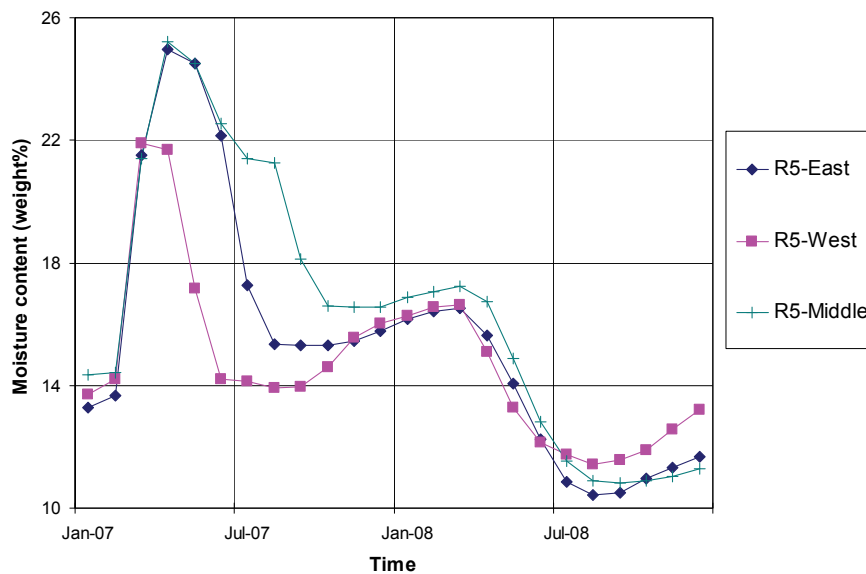

Figure 9  
Moisture content in various locations in the plywood of roof element R5 (with ventilation holes in the reinforcement beam).

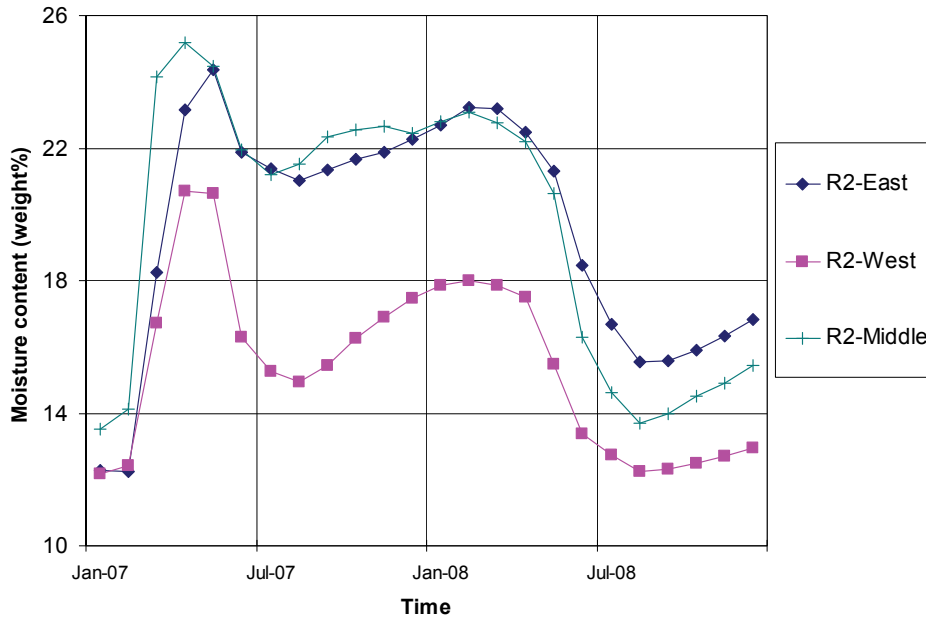

Figure 10  
Moisture content in various locations in the plywood of roof element R2 (open cornice).

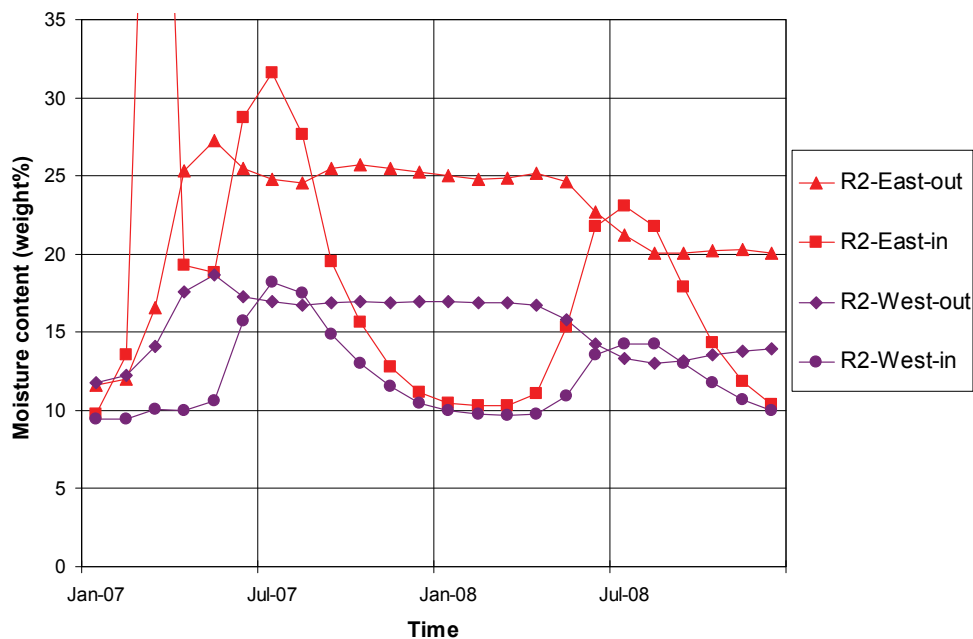

Figure 11  
Moisture content in various locations in the rafter in roof element R2 (open cornice).

We can observe that the plywood in element R1 dries much faster than element R2 during the summer period, see figure 6 - 8. The only planned difference between these two elements are the colour of the roofing membrane, R1 has a dark membrane and R2 has a light coloured membrane. This colour difference give higher external surface temperatures at element R1 compared to R2 when there is direct solar radiation hitting the surface, see figure 14 and table 6. The higher external temperature have two possible effects in regard to drying, the first being moisture transported inwards by vapour diffusion and the second being that if air is leaking through the insulation layer in the element (e.g. from west to east) the warmer air in the insulation can transport

more moisture out of the element. Only the second effect will give a net drying of moisture from the element.

## 4.2 Hygrothermal simulations

The results from the WUFI 1D simulations are shown in figure 12. We can see that the effect of varying the air change rate is significant in regard to the drying of the plywood boards. For air change rates of  $n = 0,5$  1/h and above the drying rate are similar to the measurements for the elements with ventilation holes (R4 and R5), compare figure 12 and 6. For air change rates of  $n = 0,3$  1/h and below the drying rate are similar to the measurements for the elements without ventilation holes (R2 and R3), compare figure 12 and 6. The results of the simulations confirms that intentional and unintentional ventilation of a compact flat roof, from one side of the roof to the other side, may have a significant effect on the overall drying, as was also seen in the hygrothermal measurements.

The simulations did not include the effect of sideways water vapor diffusion through the reinforcement beam ( $S_{d,beam} \approx 1,2$  m). Previous simulations have shown an effect of the sideways diffusion on the drying rate, depending on the size of the roof and the vapour resistance at the sides of the roof (Oustad et.al., 2005). At the edges of the roof we would therefore expect a faster drying rate than shown in figure 12.

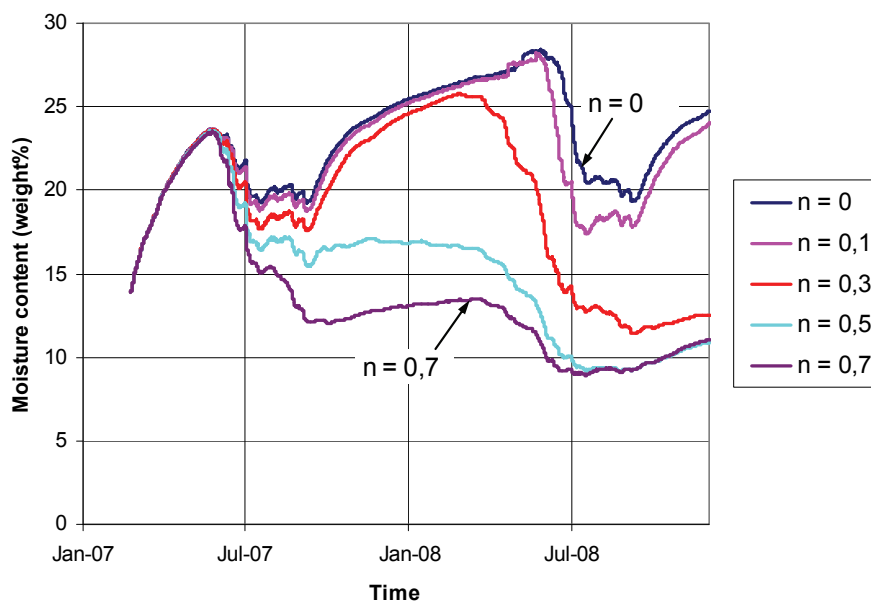

Figure 12  
WUFI 1D simulations of the moisture content of the plywood board. The air change rate of outdoor air passing through the insulation layer are varied from 0 to 0,7 1/h. Light coloured membrane (solar absorption factor  $\approx 0.65$ ).

## 4.3 Mould observations

The roof elements were opened from the inside, and inspected with the purpose to detect and observe mould growth at three different times during the first year (2007). At the first inspection (22 weeks after the water was added first time) we observed mould growth in all the five roof elements, but in a varying degree. In general there was relatively little mould growth to be observed, there were for instance no continuous layer/growth of mould. The growth was observed as small black coloured dots on the plywood and the beams dividing the elements from each other. In all the elements the growth was located in areas close to the garden irrigation hose (micro-drip-system).

Element R2 and R5 differed from the other fields having mould growth not only close to the garden irrigation hose, but also coloured dots spread out on parts of the plywood. Even so, also this growth must be described as relatively little growth. We had expected much more growth considering the high amount of built-in-moisture. Comparing element R2 and R5 the growth was a little more pronounced in element R5. Figure 13 shows a picture of how the growth looked like in element R5. During the opening of the elements the first time it was registered that the inside of the vapour barrier in element R2 and R5 was wet. During the later inspections no increase in the mould growth was observed.

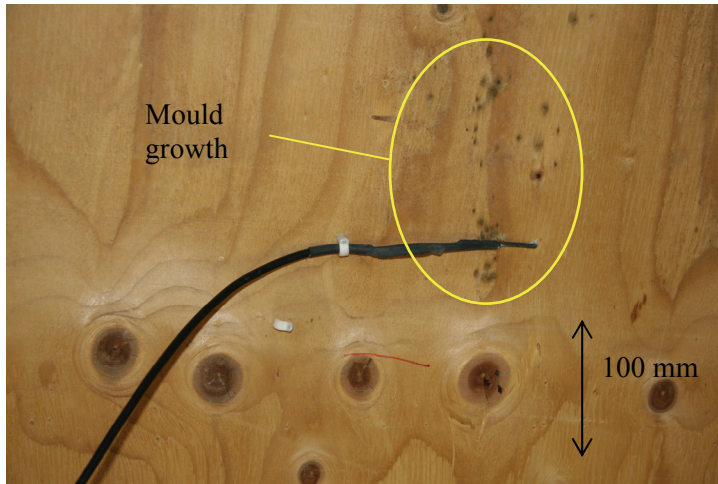

Figure 13

Typical mould growth on the plywood in element R5. Even if element R5 had most mould growth of all the roof elements, the growth is described as relatively little growth. The moisture content sensor is also shown on the picture.

Mould growth on plywood is known to appear at a relative humidity above approximately 85% (Wang 1992; Nielsen et al. 2004). In this study all the roof elements had a relative humidity well above 85% after water was added, and we observed some mould growth in all the roof elements. The mould growth was however relatively small, but there still seem to be an association between the moisture content in the plywood and the amount of growth in the different roof elements. Element R2 and R5 had more growth compared to element R1, R3 and R4. Looking at the moisture content in the plywood for these elements it is clear that the moisture content is higher in element R2 and R5 compared to element R1 and R4 (about 5-8 weight% higher during the first three months after water was added to the elements). Table 5 shows the cumulative numbers of hours at different temperature and RH in the roof elements during 2007. According to these numbers roof element R2 and R5 experience more time with RH and temperature conditions preferable for mould growth compared to element R1 and R4. The RH and temperature conditions in roof element R3 are similar to element R2 and R5 during the period between adding water and the first inspection, but still the mould growth is much less in this element. One explanation to this might be a lower viability of the spores inoculated in this element.

Table 5

Statistics for the number of hours with coinciding temperature and moisture content over certain threshold values in all of the roof elements during 2007 (total of 8761 hours). The analysed moisture content is for the middle part of the elements and the temperature is on the inward surface of the plywood. The threshold values for moisture content, 15, 18 and 20 weight%, equals an RH of approximately 80%, 90% and 95% according to the sorption curve given in table 3.

|                          | R1      | R2   | R3   | R4   | R5   |
|--------------------------|---------|------|------|------|------|
|                          | (Hours) |      |      |      |      |
| MC>15 weigth%, T>5 °C :  | 2885    | 4481 | 4346 | 1423 | 4256 |
| MC>18 weigth%, T>5 °C :  | 2435    | 4475 | 4327 | 998  | 3511 |
| MC>20 weigth%, T>5 °C :  | 1811    | 4420 | 4209 | 617  | 3261 |
| MC>15 weigth%, T>15 °C : | 1006    | 1761 | 1709 | 579  | 1697 |
| MC>18 weigth%, T>15 °C : | 773     | 1761 | 1709 | 337  | 1650 |
| MC>20 weigth%, T>15 °C : | 673     | 1744 | 1693 | 218  | 1604 |

In a field study concerning mould growth in compact roofs (Holme et.al., 2008) we found limited growth, even though the humidity levels were high enough. In that investigation we concluded that unfavourable high temperatures (amplitude > 60°C) had a negative impact on the mould growth. In this study the temperatures reaches as far as > 60°C in element no.1 and >50°C in the other roof elements, see figure 14 and table 6. Nunes et. al. (2007) has shown that the mould genera *Penicillium* has problem continuing growing at temperatures above 40°C. In a study in our laboratory (not published) we also found that the mould growth on plywood decreased when the temperature was higher than 40°C. According to these findings high temperatures can also be one explanation for the relatively limited mould growth observed in the roof elements.

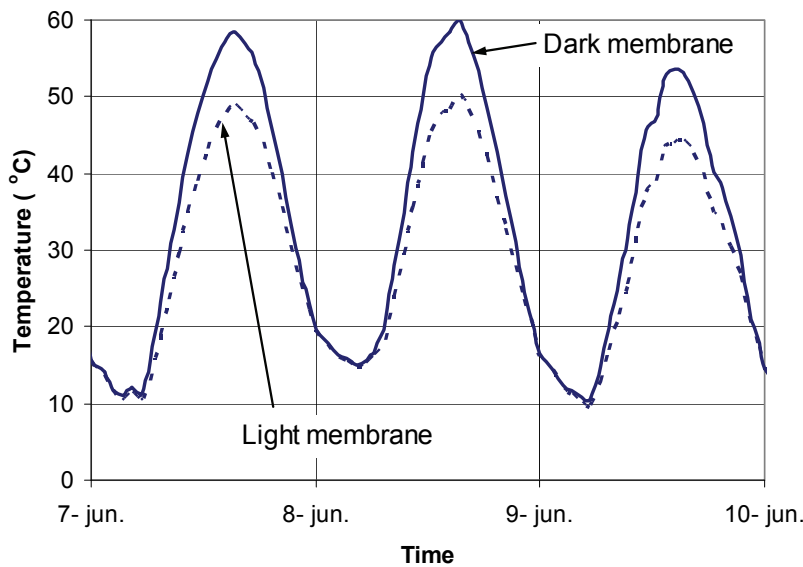

Figure 14

Typical temperature variations in the plywood during three sunny summer days for an element with a dark roofing membrane (R1) and a light roofing membrane (R2). The given temperature is on the inward surface of the plywood.

Table 6

Statistics for the temperature of the plywood in all the roof elements during 2007 (total of 8761 timer). The given temperature is on the inward surface of the plywood.

|                           | <b>R1</b> | <b>R2</b> | <b>R3</b> | <b>R4</b> | <b>R5</b> |
|---------------------------|-----------|-----------|-----------|-----------|-----------|
| <b>&gt;60 °C (hours):</b> | 2         | 0         | 0         | 0         | 0         |
| <b>60-50 °C (hours):</b>  | 81        | 4         | 0         | 4         | 5         |
| <b>50-40 °C (hours):</b>  | 234       | 121       | 112       | 134       | 138       |
| <b>40-20 °C (hours):</b>  | 1073      | 982       | 955       | 926       | 952       |
| <b>20-0 °C (hours):</b>   | 5797      | 5998      | 5901      | 5888      | 5721      |
| <b>&lt;0 °C (hours):</b>  | 1574      | 1656      | 1793      | 1809      | 1945      |
| <b>Average (°C):</b>      | 9,1       | 7,8       | 7,4       | 7,3       | 7,2       |
| <b>Maximum (°C):</b>      | 60,8      | 51,7      | 50,0      | 51,0      | 51,1      |

## 5. Conclusions

The possible positive effect of intended or unintended drying of built-in moisture by air leakages of outdoor air through the insulation layer has been investigated in this study. The measurements and the hygrothermal simulations showed a significant faster rate of drying for roof elements with a higher degree of ventilation (with small ventilation holes drilled at the edge of the roof). The drilled ventilation holes are equivalent to a continuous 1 mm opening at each side of the roof. Under windy conditions the wind pressure difference between the leeward and windward side will cause air to flow through the insulation layer of the roof, at a rate depending on; the size of the roof (and the air permeability of the insulation), the air pressure difference between the inlet and outlet and the air flow resistance at the inlet and outlet. The measurements also showed that the dominating windward side of the roof dries faster than the leeward and middle part of the roof.

The measurements have been performed on a relatively small roof, with a length under 5 m. The drying effect of air flowing from one edge of the roof to the other will depend on the total air flow resistance, i.e. the air change rate will decrease for larger roofs. This means that the drying effect for such air leakages will be smaller for large roofs. It is of course possible to combine ventilation openings at the edges of the roof with vents mounted at top of the roof, shortening the distance between the air inlet and outlet. This could also be combined with ventilation grooves (channels) in the insulation, to decrease the resistance to the air passing through the insulation.

It should however be mentioned that such ventilation as investigated in this article may have some negative consequences. The heat loss of the roof will increase due to this ventilation. This has not been investigated in this study. Salonvaara and Nieminen (2002) reported however relatively minor increase of heat loss when using small ventilation grooves to ventilate the roof, i.e. the total increase of heat loss was between 0 -5 % depending on the thickness of the insulation. Another problem with such ventilation can be that if the vapour barrier is not air tight, warm and humid indoor air may be sucked into the roof and condensation may occur. Such ventilation should therefore only be used in buildings with relatively dry indoor air (such as office buildings), and the air tightness of the vapour barrier layer must also be good.

This study also investigated the microbial growth occurring in compact wood frame roofs, for a relatively high level of built-in-moisture. The measured moisture content was so high as to expect rather extensively mould growth in the roof. The observations showed however relatively little mould growth. One possible explanation for this is the high temperature levels (over 40 °C) occurring during sunny periods, which stops the mould growth.

## 6. References

- Apneseth, T. and M. Hay (1992). *Test of portable resistance-type moisture meters* (in Norwegian). Norsk Treteknisk Institutt, Oslo, Norway.
- Bergheim, E., S. Geving and B. Time. 1998. *Hygroscopic material properties. Water vapour permeability and hygroscopic sorption curves for materials used in a test house*. Project report 234. Norwegian Building Research Institute, Trondheim, Norway.
- Bornehag, C.G., Blomquist, G., Gyntelberg, F., Jarvholm, B., Malmberg, P., Nordvall, L., Nielsen, A., Pershagen, G. and Sundell, J. 2001. *Dampness in buildings and health. Nordic interdisciplinary review of the scientific evidence on associations between exposure to "dampness" in buildings and health effects (NORDDAMP)*. *Indoor Air*, 11, 72-86.
- Bornehag, C.G., Sundell, J., Bonini, S., Custovic, A., Malmberg, P., Skerfving, S., Sigsgaard, T. and Verhoeff, A. 2004. *Dampness in buildings as a risk factor for health effects, EUROEXPO: a multidisciplinary review of the literature (1998-2000) on dampness and mite exposure in buildings and health effects*. *Indoor Air*, 14, 243-257.
- Du, Q.P. et.al. (1991). Die Genauigkeit der elektrischen Holzfeuchtemessung nach dem Widerstandprinzip. *Holz als Roh- und Werkstoff*, Vol 49, pp 305-311.
- Foarde, K. K., D. W. VanOsdell, et al. (1996). "Evaluation of Fungal Growth on fiberglass Duct Materials for Various Moisture, Soil, Use and Temperature Conditions." *Indoor Air* 83-92.
- Jansen E. and Myklebust I. 2007. *Studie av muggsoppvekst på bygningsmaterialer – risiko for vekst av muggsopp på vindsperre*. Master thesis. Norwegian University of Science and Technology, Trondheim, Norway
- Geving S. and S. Uvsløkk. 2000. *Moisture conditions in timber frame roofs and wall structures – test house measurements of heat-, air and moisture transfer models*. Project report 273 Norwegian Building Research Institute, Trondheim, Norway.
- Holme, J. et.al. 2008. *Moisture and Mould Growth in Compact Roofs – Results from a Three-Stage Field Survey*. Proceedings of 8<sup>th</sup> Symposium on Building Physics in the Nordic Countries, Copenhagen, Denmark, June 16-18<sup>th</sup>, pp1221-1228.
- Künzel H.M. 1995. *Simultaneous Heat and Moisture Transport in Building Components. - One- and two-dimensional calculation using simple parameters*. IRB Verlag, Germany.
- Nielsen K.F., G. H., Uttrup L.P, Nielsen P.A. 2004. *Mould growth on building materials under low water activities. Influence of humidity and temperature on fungal growth and secondary metabolism*. *International Biodeterioration and Biodegradation*, Vol 54, p.325-336.
- Nunes C., Usall J., et. al. 2007. *Effect of high temperature treatments on growth of penicillium spp. and their development on "Valencia" oranges*, *Food Science and Technology International*, 13;63
- Noreng, K. et.al. 2005. *Moisture in compact roofs – results of a two stage field survey*. Proceedings of 7<sup>th</sup> Symposium on Building Physics in the Nordic Countries, Reykjavik, Iceland, June 13-15<sup>th</sup>, pp695-702.



Oustad, M., S. Uvsløkk and A. Gustavsen. 2005. *The drying potential of compact roofs – diffusion* (in Norwegian). Project report 386. ISBN 82-536-0875-6. Norwegian Building Research Institute, Trondheim.

Salonvaara, M. and J. Nieminen. 2002. *Hygrothermal performance of low-sloped roofs with groove ventilation*. Proceedings of 6<sup>th</sup> Symposium on Building Physics in the Nordic Countries, Trondheim, Norway, June 17-19<sup>th</sup>, pp. 239-246.

Uvsløkk, S. 2008. *Selfdrying mechanisms in compact roofs* (in Norwegian: Selvuttørkingsmekanismer for kompakte tak). Project report 19, SINTEF Building and Infrastructure, Trondheim, Norway. ISBN 978-82-536-1023-8.

Viitanen, H. 2004. *Critical conditions for the mould growth in concrete and in other materials contacted with concrete - durability of concrete against mould growth*. VTT-Work-6. Finland.

Wang, Q. (1992). *Wood-Based Boards -- Response to Attack by Mould and Stain Fungi*. Uppsala, Sveriges Lantbruksuniversitet - Institutionen för virkeslära

# Appendix

## Appendix 1 – Measured moisture contents in the plywood

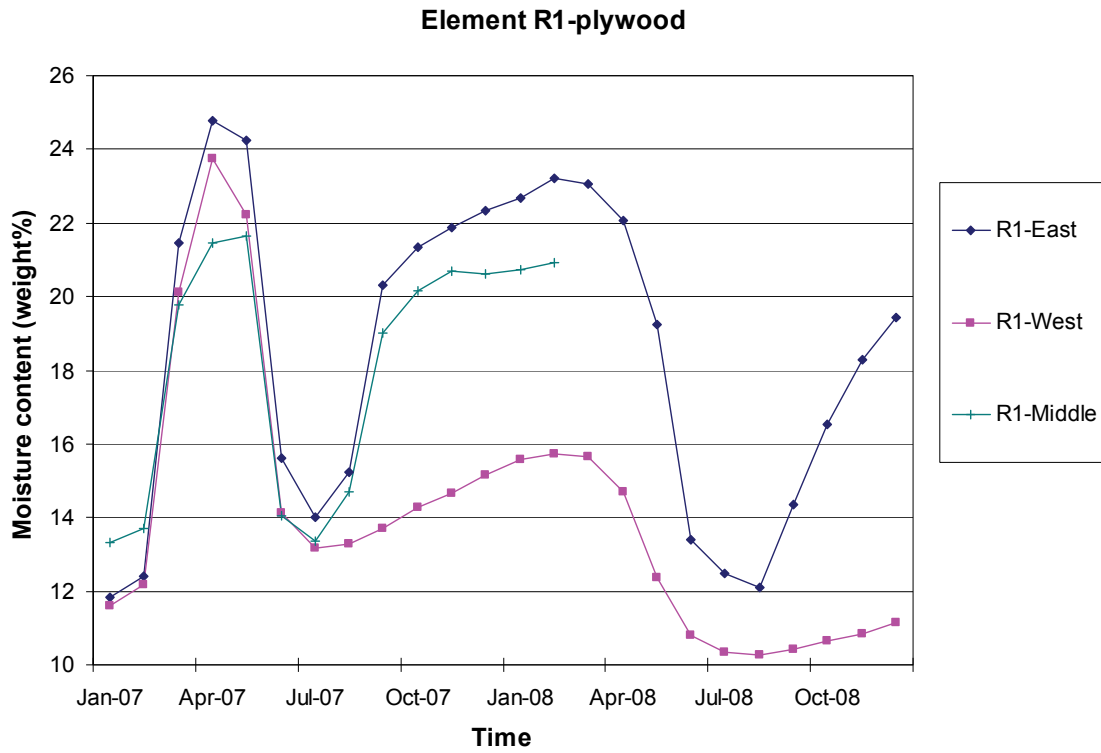

Element R2-plywood

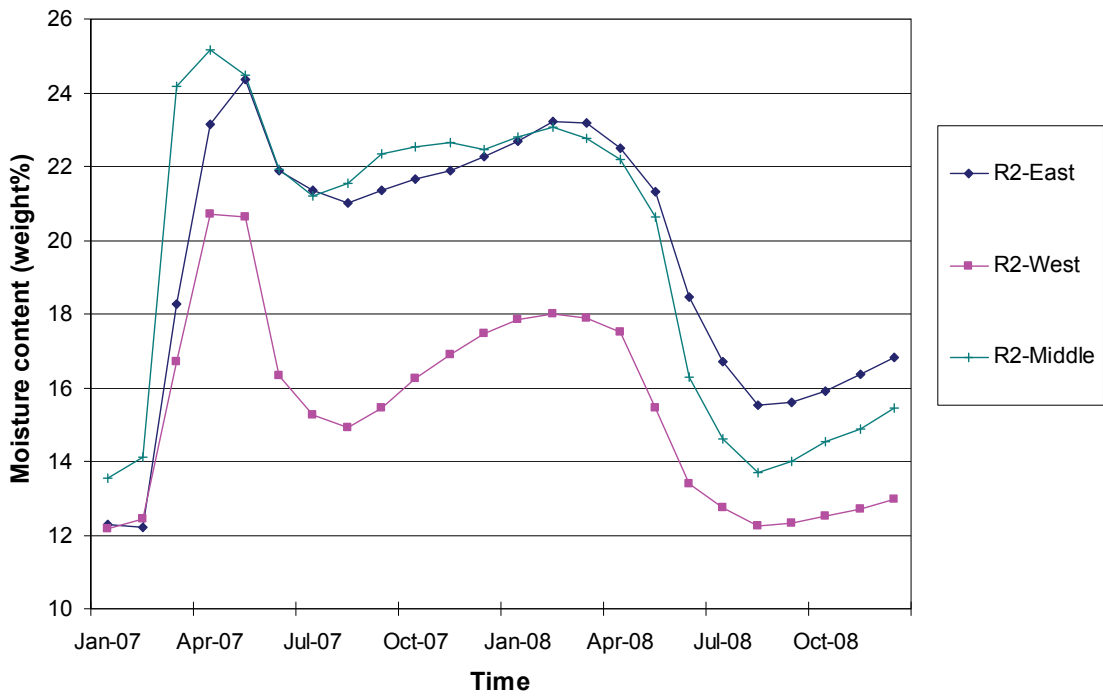

Element R3-plywood

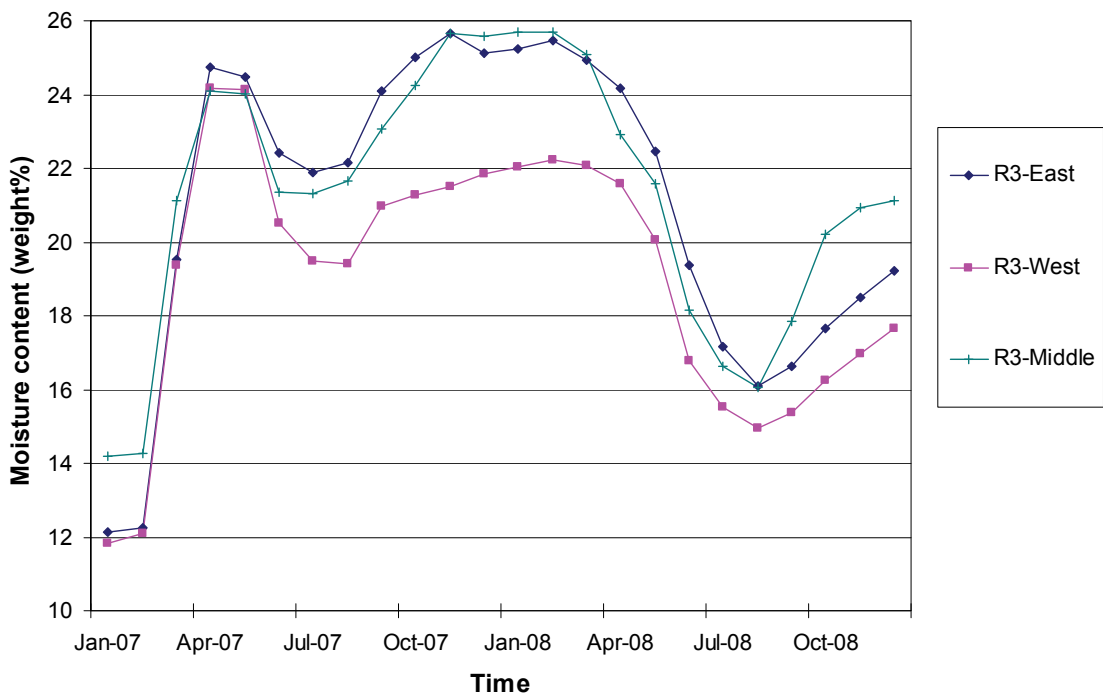

Element R4-plywood

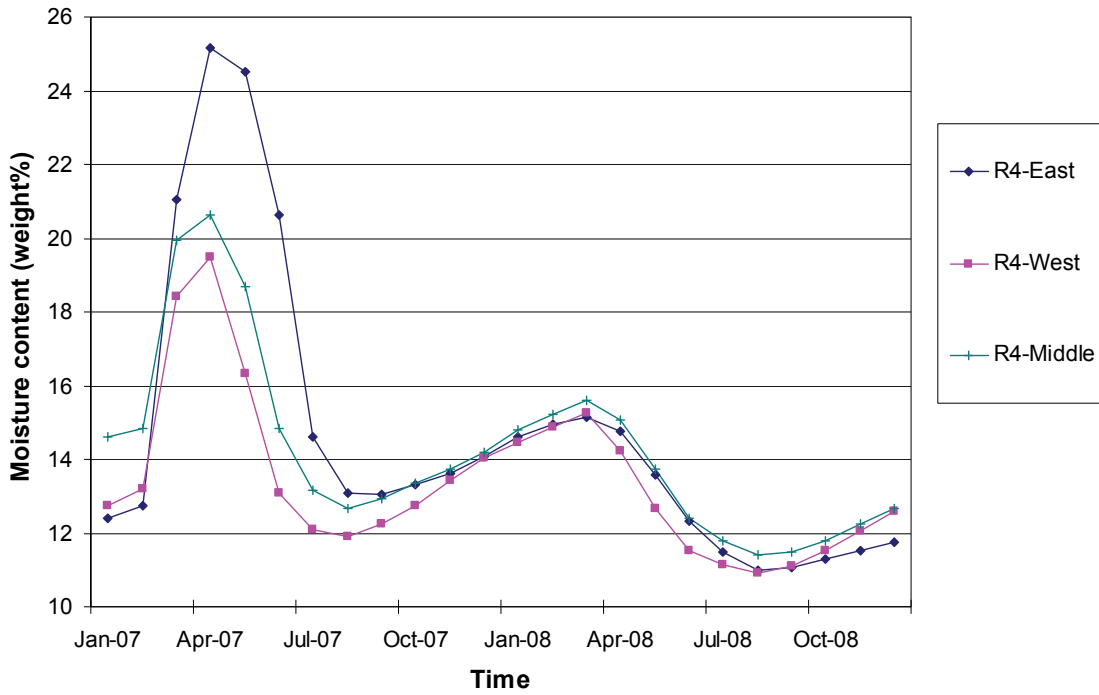

Element R5-plywood

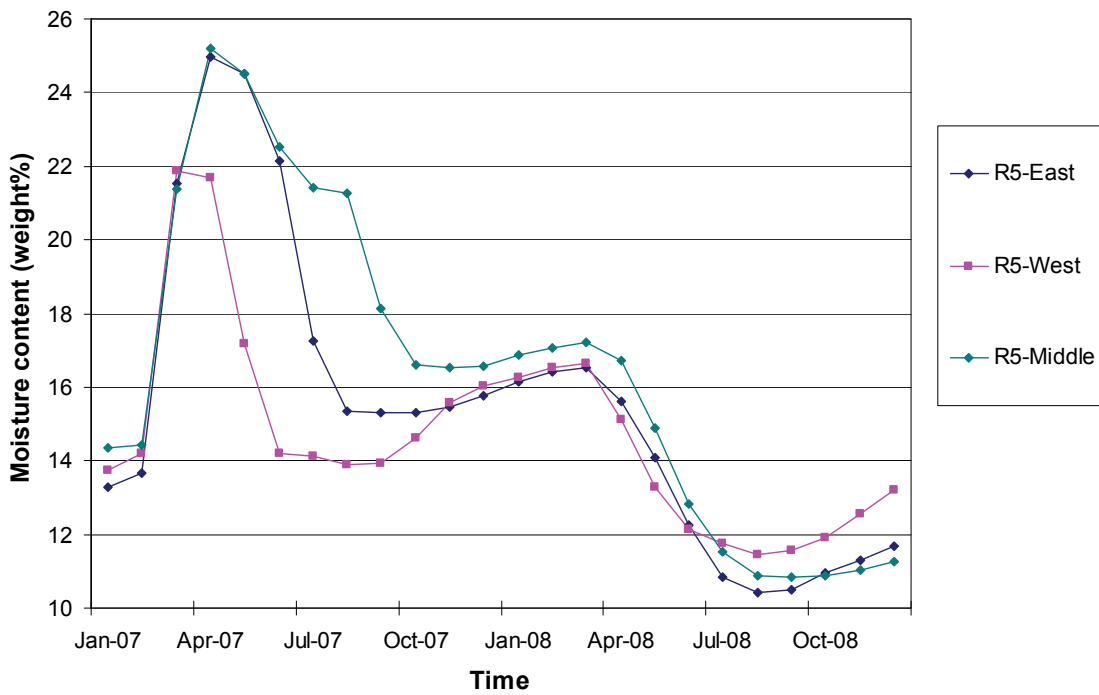

## Appendix 2 – Measured moisture contents in the wooden rafters

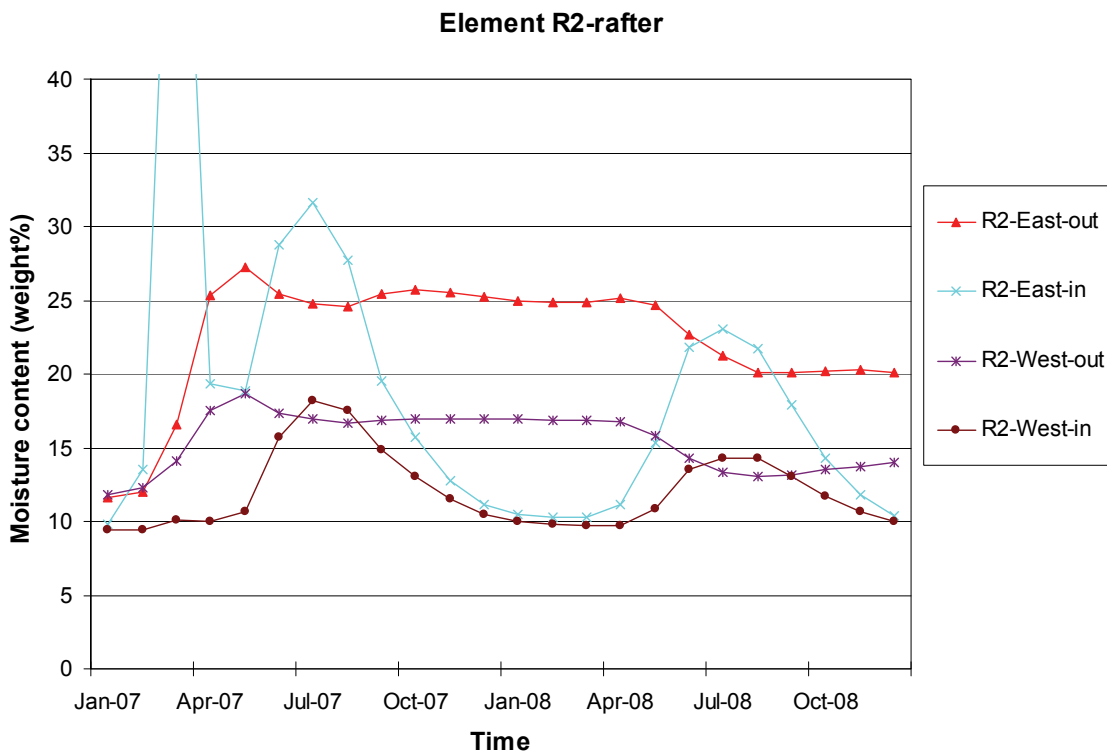
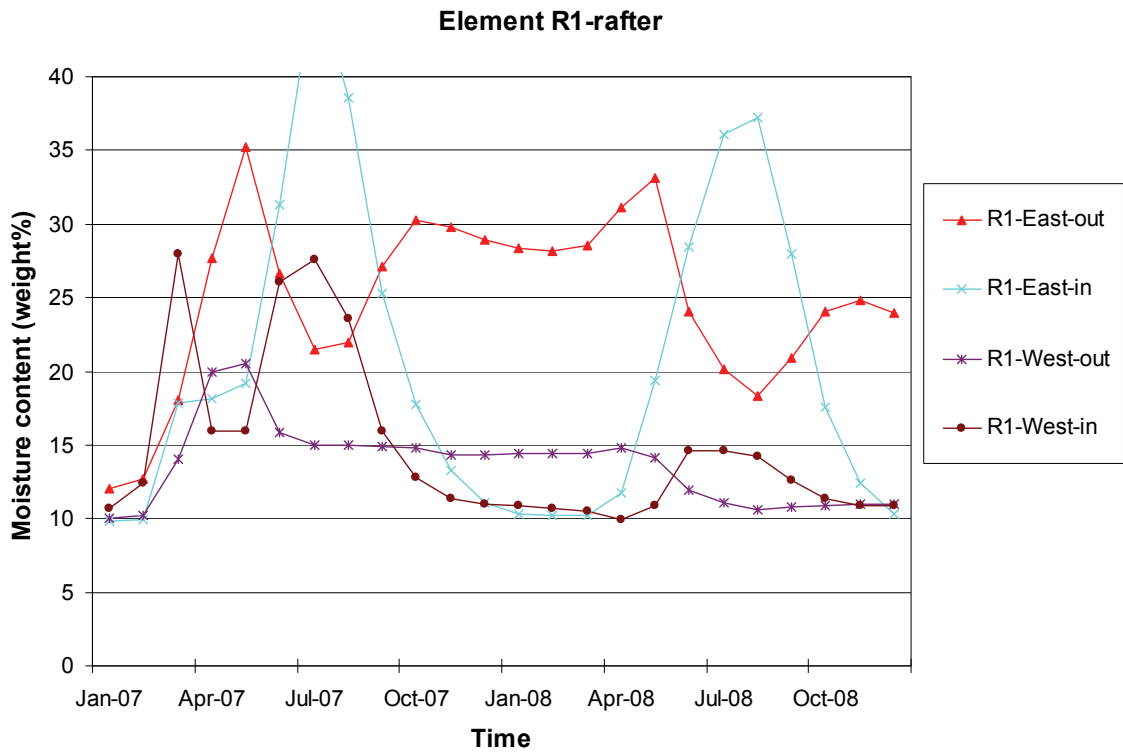

Element R3-rafter

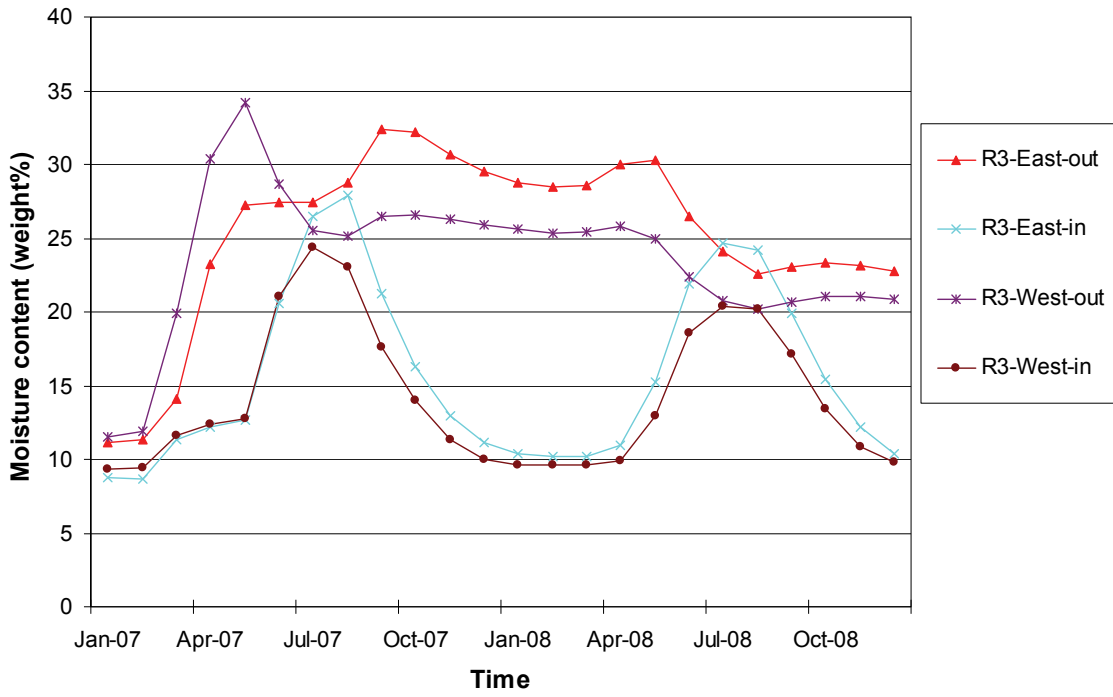

Element R4-rafter

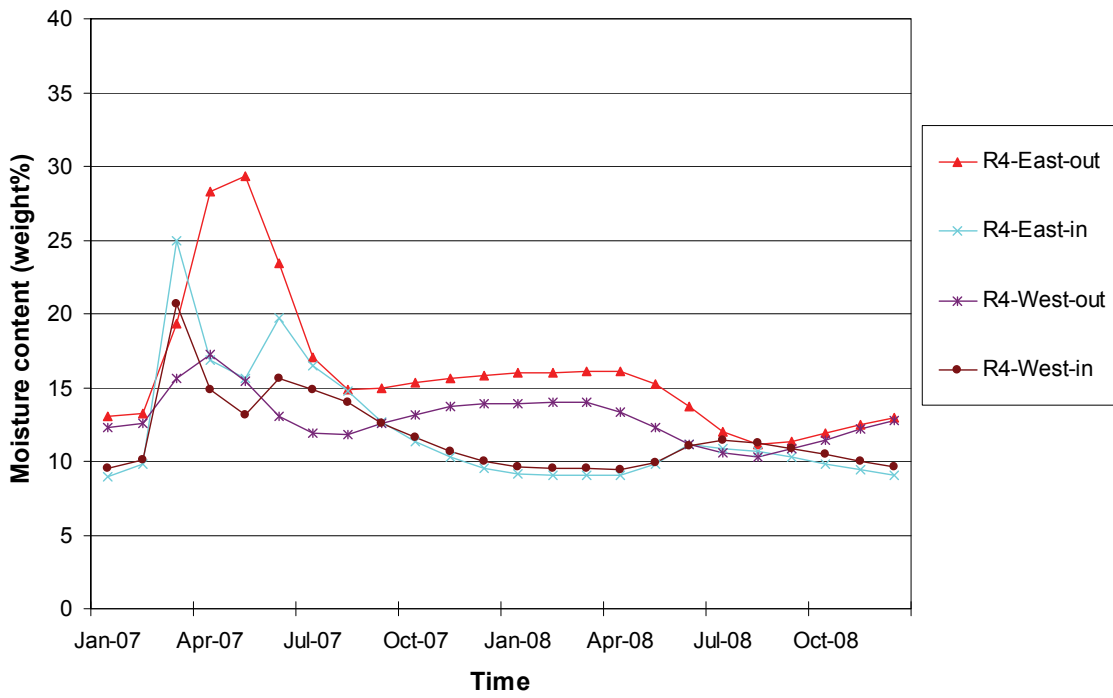

**The SINTEF Group** is the largest independent research organization in Scandinavia. Our vision is “Technology for a better society”. Our goal is to contribute to wealth creation and to the sound and sustainable development of society. We generate new knowledge and solutions for our customers, based on research and development in technology, the natural sciences, medicine and the social sciences.

**SINTEF Building and Infrastructure** is the third largest building research institute in Europe. Our objective is to promote environmentally friendly, cost-effective products and solutions within the built environment.

**SINTEF Building and Infrastructure** is Norway’s leading provider of research-based knowledge to the construction sector. Through our activity in research and development, we have established a unique platform for disseminating knowledge throughout a large part of the construction industry.